



 **BINALIA**®

 **Verofer**®

CATALOGUE 2023



Verofer[®]

Cylinders and
Complements

 **BINALIA**[®]

Handles & Accessories



MADE IN EU



SC BINALIA SRL: at the beginning of the nineties of last century, Binalia was already working brass manufactures, and it was taken from a group of European entrepreneurs, who, in their original nations, praised solid experiences in the specific sector. Between these entrepreneurs there were persons engaged as much as in the production and in the marketing of those goods. The common research of new business opportunity was the glue for their different experiences. In that period the company knew a thorough renovation, and it was endowed of cutting edge machineries conducted by specialized technical. Beginning from the first years of the new millennium the company is the leading actor as much as corporate structures changes and a redefinition of its own core business: from a subject acting on behalf of third parties to a company with its own range of products for doors and windows, ranging over brass and other raw materials.

SC VEROFER SRL: Verofer was founded at the end of the nineties of last century, from a group of entrepreneurs both Romanians and Italians, who were able to count on the experience of Mr Vercellini, the majority shareholder, working from long time in the metal mechanical environment. He, and his staff, planned the diversification of the productions, adding to the traditional line of handles and locks even the line of security cylinders, to offer to the costumers a diversified fan of goods dedicated at the security of buildings. In the years, the productive flairs of Mr Vercellini have favored the emergence of synergies with European companies (leaders in the industry of doors and windows), which praise a specialization both in the realization of hinges for doors, anodized handles, high system of locks, and in the innovative sector of the sliding doors.

In the next months, the productive ways of Binalia and Verofer will join, to create an unique business reality able to purpose on the market as absolute protagonist in its sector.

Always paying attention to the requests of the costumers, we could better head the chance in the domestic and foreign market, combining the energy of the staff both of Verofer and Binalia.

The hallmark of our products is the full respect of the European standards of quality, security and design. It is no coincidence, for example, that our cylinders are completely realized in brass, with raw material certificate EN 10 204 2.2 and have implemented a quality system ISO 9001:2008.

A large range of our production is realized in brass, alloy of copper and zinc, which is easy to mold and hard proof to corrosion, while our manufactures in zamak respect the European standard as 410 EN1774 and are ermined with copper, which isolates and protects against corrosive agents.

Protagonists from years on the international market as well as on the Romanian market, for Binalia and Verofer, during their diversified production history, the respect of costumers has been their qualifying point. The companies succeeded by achieving productive performances, where the quality of production is combined with style and good functionality of the various range of goods which gives birth to the new catalogue we are pleased to present.

To celebrate the 30th anniversary of our foundation, we created a modern website where you can find technical and specific information about every product.



SC.Binalia SRL: Cu o prezență activă în domeniul producerii de articole, Binalia a fost înființată la începutul anilor '90 ai secolului trecut de către un grup de antreprenori europeni care aveau deja avantajul unei experiențe solide, cu precădere în sectorul realizării produselor din alamă dar și în domeniul comercializării acestora.

Modalitatea optimă de a fructifica sinergia diverselor experiențe era aceea de a porni împreună spre căutarea unor noi oportunități de business.

În acea perioadă renaște o profundă restructurare a firmei prin implementarea unor tehnologii de avangardă puse în operă de un personal specializat.

În primii ani ai noului mileniu Binalia a cunoscut modificări atât în structura acționariatului dar mai ales și-a redefinit propriul core business trecând de la etapa în care realiza produse la cererea firmelor partenere la definirea unei game proprii de articole pentru uși și ferestre realizate atât din alamă cât și din zamac.

Pe parcursul următoarelor luni, Binalia și Verofer își vor unifica departamentele de producție, cu scopul de a da viață unei unice realități corporative capabilă să se impună pe piață ca un adevărat lider al branșei pe care activează.

Dintotdeauna atenți la exigențele clienților noștri și cumulând energiile partenerilor noștri strategici cu specializarea personalului tehnic provenit atât din Binalia cât și din Verofer vom putea înfrunta cu forță maximă provocările pe care ni le adresează piața indigenă dar și cea internațională.

Semnul distinctiv al produselor noastre îl constituie deplinul respect al standardelor europene de calitate, siguranță și design. Astfel în mod deosebit cilindri noștri sunt realizați în întregime din alamă, utilizând materie primă certificată EN 10 204 2.2 și având implementat un sistem de management al calității ISO 9001:2008.

Mare parte dintre produsele noastre sunt realizate din alamă, aliaj de cupru și zinc, ceea ce permite deopotrivă o prelucrare facilă și o rezistență crescută la coroziune, în timp ce articolele din zamac respecta normele europene 410 EN 1774 și sunt supuse unui tratament galvanic care le protejează de acțiunea agenților corozivi.

Prezente ca protagoniste atât pe piața internă dar și pe cea internațională, Binalia și Verofer - de-a lungul bogatei lor istorii productive - au transformat respectul față de client într-un element definitoriu, având ca scop atingerea unei performanțe productive prin care calitatea procesului de producție se combină cu stilul și funcționalitatea bogatei game de produse care au dat naștere acestui nou catalog pe care ne face plăcere să vi-l prezentăm.

Cu ocazia aniversării a 30 de ani de activitate, firmele noastre întâmpina clienții online cu un nou site web, modern, ușor de consultat și bogat în date tehnice specifice fiecărui articol.



SC Verofer SRL: Înființată la sfârșitul anilor '90 de un grup de investitori de origine italiană și română care au contat pe experiența lui Girolamo Vercellini, acționar majoritar, care a planificat diversificarea gamei de produse prin completarea gamei tradiționale de articole din alamă și zamac cu cilindri de siguranță, din preocuparea de a oferi clienței o gamă cât mai variată de articole dedicate siguranței clădirilor civile, comerciale și industriale.

Intuițiile productive ale lui Vercellini au favorizat de-a lungul timpului nașterea unor sinergii cu alte firme europene (lideri în sectorul de feronerie pentru uși și ferestre), în special italiene, specializate la rândul lor în producerea unor sisteme inovative de glisare, realizarea de balamale cilindrice, producerea manerelor din aluminiu anodizat etc.

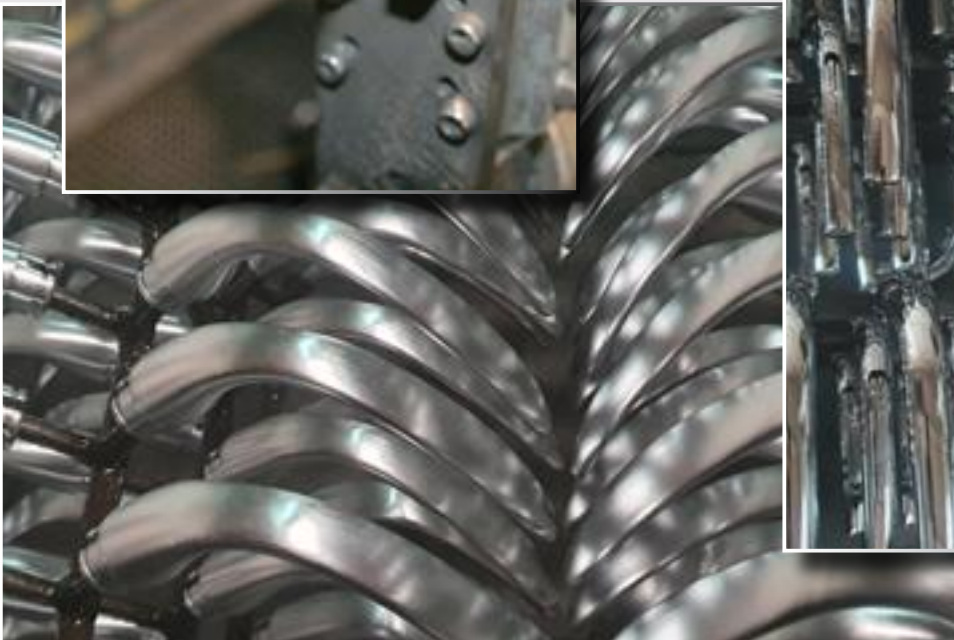



BRESCIA - ITALY

+39 0365 88052



ARAD - ROMANIA

+40 257 270 999



ARAD - ROMANIA

+40 257 289 734

BINALIA SRL has obtained the certification for conformity of Management System according to the UNI EN ISO 9001 : 2008

sc BINALIA SRL detine certificarea Sistemului de Management in conformitate standardul UNI EN ISO 9001 : 2008



BINALIA®
Handles & Accessories



“Nu l-am întrebat pe angajator despre salariul pe care mi-l va da sau despre munca pe care va trebui să o fac, nu mi-a păsat: singurul lucru care m-a interesat a fost să-mi schimb viața.

Precum companiile mele transformă materiile prime pentru a produce cilindri de siguranță și mânere pentru uși, tot așa inventivitatea mea a reușit să transforme sacrificiile făcute în conștientizarea faptului că fiecare obiectiv este realizabil.”

“I didn't ask my employer about the salary he would give me or the job I would have to do, I didn't care: the only thing that interested me was to change my life.

Just as my companies transform raw materials to produce cylinders and door handles, so my resourcefulness has been able to transform the sacrifices made into the awareness that every goal is achievable.”

“Non chiesi al mio datore di lavoro il salario che mi avrebbe dato o il lavoro che avrei dovuto fare, non mi interessava: l'unica cosa che mi interessava era cambiare la mia vita.

Così come le mie aziende trasformano materie prime per produrre cilindri e maniglie per porte, così la mia intraprendenza ha saputo trasformare i sacrifici fatti nella consapevolezza che ogni meta è raggiungibile.”













Girolamo Vercellini

MATERIALS & FINISHING

BRASS

ZAMAK

STEEL

	POLISHED BRASS <i>ALAMA LUCIOS</i>	OLV	ZOL	-
	SATIN BRASS <i>ALAMA SATINAT</i>	OSV	-	-
	BRONZED BRASS <i>ALAMA BRONZAT</i>	OBV	-	-
	SCRATCHED BRONZE <i>BRONZAT GRAFIAT</i>	OBG	ZBG	-
	BRONZE MATT <i>BRONZAT MAT</i>	OBY	-	-
	ANTIQUE BRASS <i>ALAMA ANTIK</i>	OBA	-	-
	POLISHED CHROME <i>CROM LUCIOS</i>	OCL	ZCL	CL
	CHROME SATIN <i>CROM SATINAT</i>	OCS	ZCS	CS
	NICKEL SATIN <i>NICKEL SATINAT</i>	ONS	ZNS	-
	POLISHED STAINLESS STEEL <i>INOX LUCIOS</i>	-	-	INOX
	SATIN STAINLESS STEEL <i>INOX SATINAT</i>	-	-	INOX SAT
	BLACK <i>NEGRU</i>	RAL 9005	A-Z-OJ	

ALLUMINIUM

	ANODIZED SILVER <i>ANODIZAT ARGINTIU</i>	F1A		GOLDEN PAINT <i>VOPSIT AURIU</i>	F6A
	ANODIZED BRONZE <i>ANODIZAT BRONZAT</i>	F4A		WHITE <i>ALB</i>	A-Z
	SILVERED PAINT <i>VOPSIT ARGINTIU</i>	F5A		BROWN <i>MARO</i>	A



FROM NOW AVAILABLE FOR ALL THE RANGE BRASS LINE



WIEN

21292P - OBA

▶ page 43

ANTIQUE BRASS
ALAMA ANTIK



DI TENDENZA

FROM NOW AVAILABLE FOR ALL THE ZINC RANGE



DIANA

23080R08 - RAL 9005

▶ page 15

NEW FINISHING



INDEX









Q - LINE SERIA Q

	CLIO	PAG. 18
	DIANA	PAG. 15
	ELISA	PAG. 14
	GIUSSY	PAG. 19

	LUNA	PAG. 13
	NEW PRAGUE	PAG. 17
	VITTORIA	PAG. 18

BRASS LINE SERIA ALAMA

	ALICANTE	PAG. 24
	ALT WIEN	PAG. 42
	ALTEA	PAG. 22
	AMBRA	PAG. 37
	ATENA	PAG. 40
	BETA	PAG. 46
	CLAUDIA	PAG. 45
	COMBI	PAG. 51
	COSMO	PAG. 49
	ELEGANT	PAG. 41
	EMMA	PAG. 16
	EXPO	PAG. 12
	FIORE	PAG. 25
	GAYA	PAG. 35
	GIULIA	PAG. 33
	GRANADA	PAG. 36
	ISEO	PAG. 38

	KATY	PAG. 30
	LUXOR	PAG. 59
	MADEIRA	PAG. 24
	MAURA	PAG. 29
	NINFEA	PAG. 34
	ONDA	PAG. 31
	PANDA	PAG. 47
	PAPERINO	PAG. 51
	SIMONA	PAG. 50
	TOLOSA	PAG. 26
	TEKNA	PAG. 19
	TRENDY	PAG. 32
	VENUS	PAG. 27
	VIENNETTA	PAG. 44
	WIEN	PAG. 43
	WING	PAG. 48

SECURITY LINE SERIA SECURITY

	BERLINO	PAG. 55
	GOLF	PAG. 28
	LAURA	PAG. 53

	PARIGI	PAG. 54
	PARIGI DEC	PAG. 54
	VICTORIAN	PAG. 28



ZINC LINE SERIA ZINC

	AMBRA ECO	PAG. 66
	AMBRA ECO MINUS	PAG. 69
	BETA ECO	PAG. 67
	CARINA	PAG. 64
	ISCHIA	PAG. 68
	MAREA	PAG. 65
	MARGARET	PAG. 64
	MONICA	PAG. 65
	RIO	PAG. 70
	ROBY	PAG. 63
	SOFIA	PAG. 70
	VIENNETTA ECO	PAG. 69

ALLUMINIUM LINE SERIA ALUMINIU

	25164P	PAG. 73
	ARAD	PAG. 72
	MURES	PAG. 72
	VENERA	PAG. 7

INOX LINE SERIA INOX

	NOVANTA	PAG. 62
	U	PAG. 62

ACCESSORIES LINE SERIA ACCESORII

PAG. 53/62

CYLINDERS LINE SERIA CILINDRI

PAG. 81/95

EUROPEAN PROFILE CYLINDERS
CILINDRI PROFIL EUROPEAN

SECURITY CYLINDERS WITH REVERSIBLE KEYS
CILINDRI DE SIGURANTA CU CHEI REVERSIBILE

BATHROOM CYLINDERS & THUMBTURN
CILINDRI CU BUTON PENTRU BAIE

CYLINDERS & THUMBTURN - 3 KEYS
CILINDRI CU BUTON & CHEI

SINGLE CYLINDERS & THUMBTURN
SEMICILINDRI CU BUTON

SINGLE CYLINDERS & KEYS
SEMICILINDRI & CHEI

SPECIAL APPLICATIONS
APPLICATII SPECIALE

LOCKS LINE SERIA BROASTE

035-29	PAG. 97
035-59	PAG. 102
035-91	PAG. 100
035-96	PAG. 101
035-154	PAG. 98
035-171L	PAG. 108
035-174	PAG. 99
035-178	PAG. 103
035-183	PAG. 102
035-199	PAG. 96
035-204	PAG. 103
035-207	PAG. 103
035-210	PAG. 103

SLIDING DOORS LINE

SERIA USI GLISANTE

PAG. 104/106

COMPONENTS COMPONENTE

PAG. 107



EXPO



23088R08 - ZCS
 Handle on rose
Maner cu rozeta

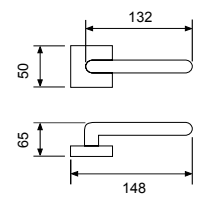

23088DK - ZCS
 Tilt and turn handle
 DK

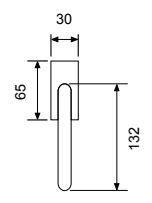



 **LUNA**

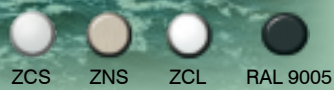

23084R08 - ZCS
Handle on rose
Maner cu rozeta

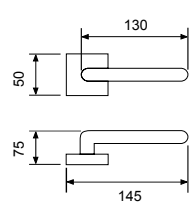

23084DK - ZCS
Tilt and turn handle
DK

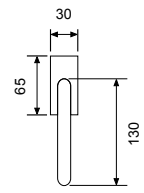



Design: **Studio.Gea.Italia**

 **ELISA**

-  ZCS
-  ZNS
-  ZCL
-  RAL 9005



23081R08 - ZCS
Handle on rose
Maner cu rozeta

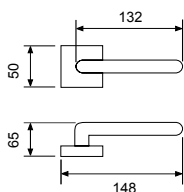

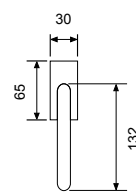

33081DK - ZCS
Tilt and turn handle
DK





Design: **Studio.Gea.Italia**

 **DIANA**

- 
ZCS
- 
ZNS
- 
ZCL
- 
RAL 9005



23080R08 - RAL 9005

Handle on rose
Maner cu rozeta

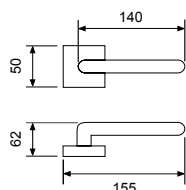

33080DK - RAL 9005

Tilt and turn handle
DK

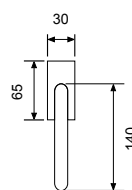



Design: **Studio.Gea.Italia**



23086R08F - ZCS
 Handle on rose
Maner cu rozeta

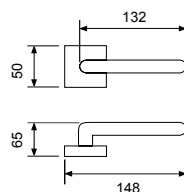

23086DK - ZCS
 Tilt and turn handle
 DK

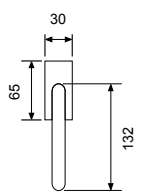



 **NEW PRAGUE**



23070R08 - ZCS
 Handle on rose
Maner cu rozeta

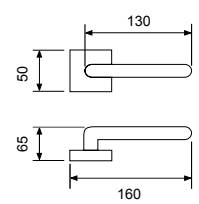



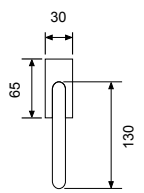

33070DK - ZCS
 Tilt and turn handle
 DK





CLIO

-  ZCS
-  ZNS
-  ZCL/ZCS
-  RAL 9005



23061R08 - ZCL/ZCS

Handle on rose
Maner cu rozeta

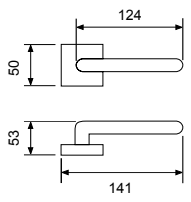

33061DK - ZCS

Tilt and turn handle
DK

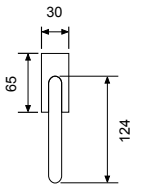

VITTORIA

-  ZCS
-  ZNS
-  ZC/LZCS
-  RAL 9005



23013R08 - ZCS

Handle on rose
Maner cu rozeta

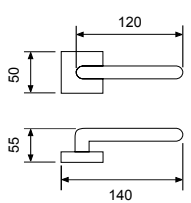

23013DK - ZCS

Tilt and turn handle
DK

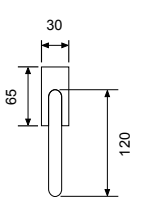



TEKNA



23085R08 - ZCS
Handle on rose
Maner cu rozeta

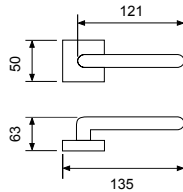

23085DK - ZCS
Tilt and turn handle
DK

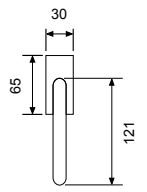

GIUSSY

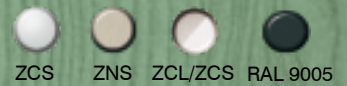

23063R08 - ZCL/ZCS
Handle on rose
Maner cu rozeta

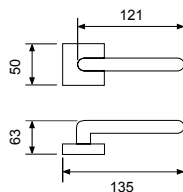

33063DK - ZCS
Tilt and turn handle
DK

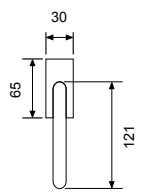



21200R09 - OBG
Handle on rose
Maner cu rozeta

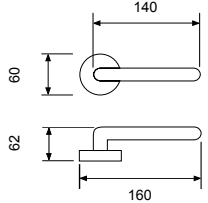

21200P - OBG
Handle on plate
Maner cu placa

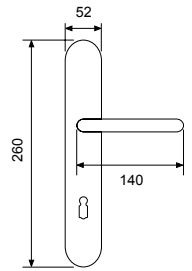

31200DK - OBG
Tilt and turn handle
DK

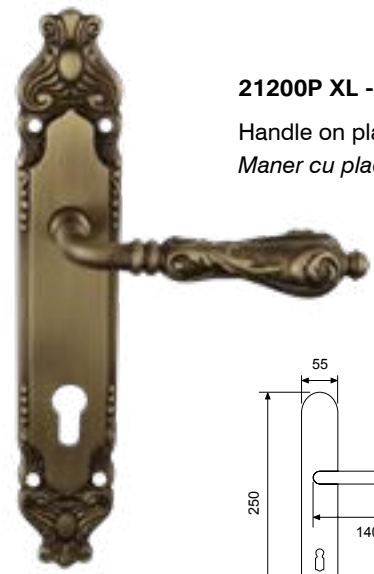
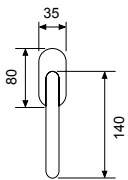

21200P XL - OBG
Handle on plate
Maner cu placa

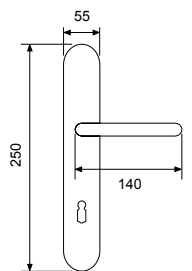

XL MAGNUM SIZE
EXTERNAL DOORS







21070R04 - OBG

Handle on rose
Maner cu rozeta

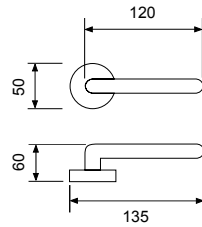

21070P - OBG

Handle on plate
Maner cu placa

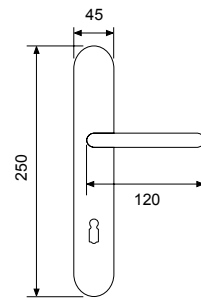

2070 - OBG

Window's plate on handle
Miner cu sild pt fereastr

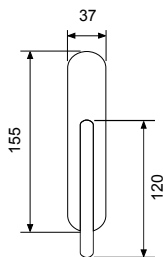

LEFT



RIGHT



31070DK - OBG

Tilt and turn handle
DK

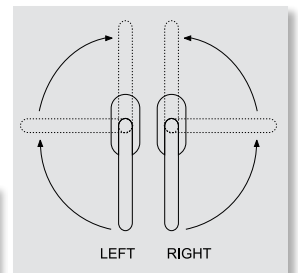
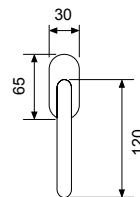

Please specify when is LEFT
Precizati Dreapta sau Stanga



MADEIRA

21094P - OBG

Handle on plate



Maner cu placa

6



OBG



OBA

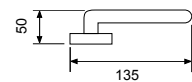
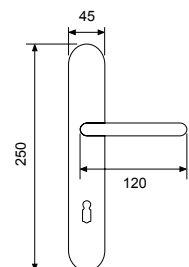

ALICANTE

21079P - OBG

Handle on plate



Maner cu placa

6



OBG



OBA

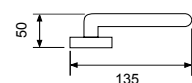
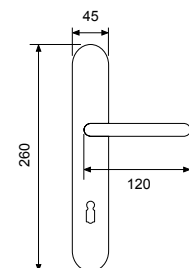



21088R03 - OBG
 Handle on rose
Maner cu rozeta

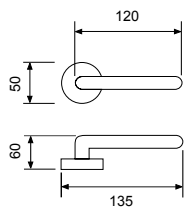

21088P - OBG
 Handle on plate
Maner cu placa

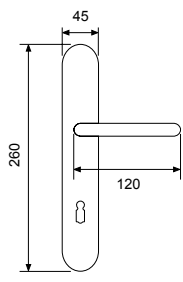

LEFT

RIGHT



31088DK - OBG
 Tilt and turn handle
 DK

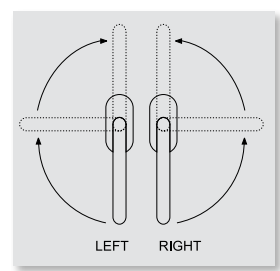
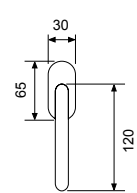

Please specify when is LEFT
Precizati Dreapta sau Stanga



21058R03 - OBG
Handle on rose
Maner cu rozeta

21058P - OBG
Handle on plate
Maner cu placa

2058 - OBG
Window handle
Cremon

31058DK - OBG
Tilt and turn handle
DK

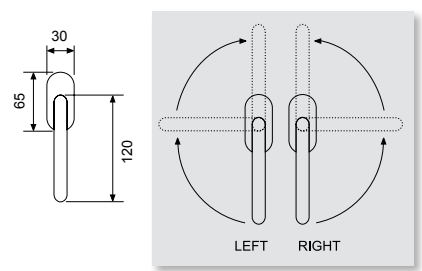
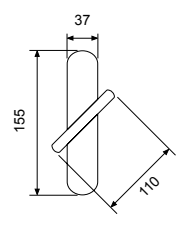
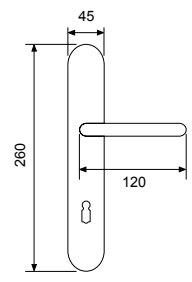
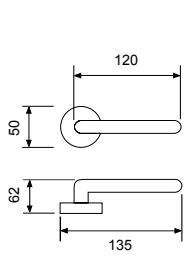

Please specify when is LEFT
Precizati Dreapta sau Stanga



21034R04 - OGR
 Handle on rose
Maner cu rozeta

21034P - OBG
 Handle on plate
Maner cu placa

2034 - OBG
 Window's plate on handle
Miner cu sild pt fereastr

31034DK - OBG
 Tilt and turn handle
 DK

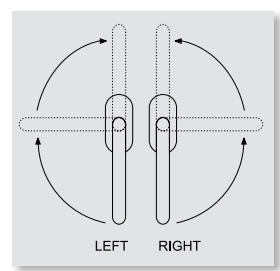
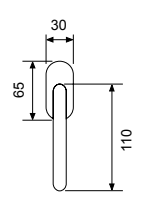
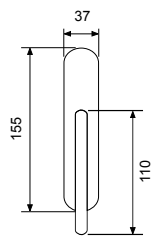
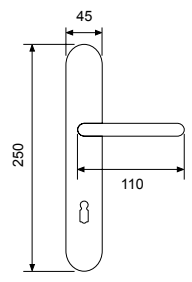
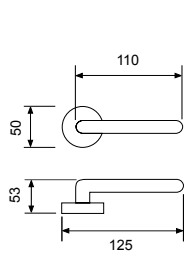

Please specify when is LEFT
Precizati Dreapta sau Stanga



GOLF

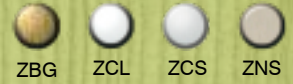

23998R03 - ZCS

Handle on rose
Maner cu rozeta

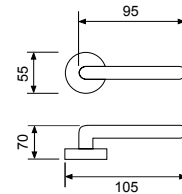

VICTORIAN



21808R03 - OLV

Handle on rose
Maner cu rozeta

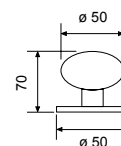



21064R03 - OLV
Handle on rose
Maner cu rozeta

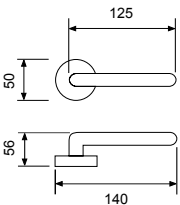

21064P - OLV
Handle on plate
Maner cu placa

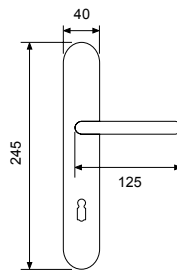

LEFT

RIGHT



31064DK - OLV
Tilt and turn handle
DK

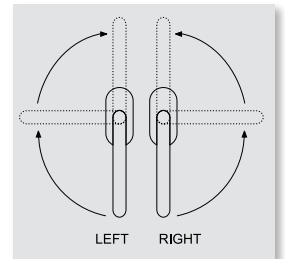
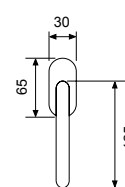

Please specify when is LEFT
Precizati Dreapta sau Stanga



21077R04 - OLV
Handle on rose
Maner cu rozeta

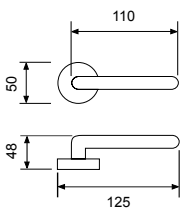

21077P - OLV
Handle on plate
Maner cu placa

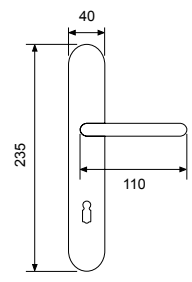

2077 - OLV
Window's plate on handle
Miner cu sild pt fereastr

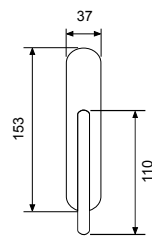

31077DK - OLV
Tilt and turn handle
DK

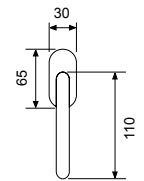

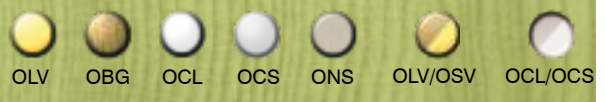

21072R04 - OCL/OCS
 Handle on rose
Maner cu rozeta

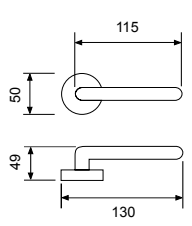

21072P - OCL/OCS
 Handle on plate
Maner cu placa

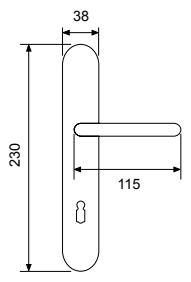

LEFT

RIGHT



31072DK - OCL/OCS
 Tilt and turn handle
 DK

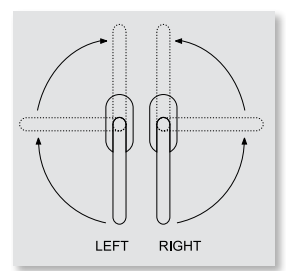
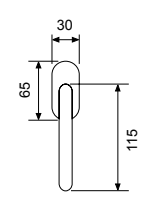

Please specify when is LEFT
Precizati Dreapta sau Stanga

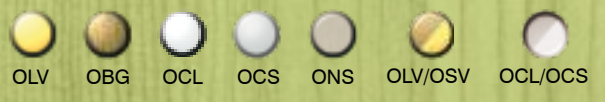

21075R03 - OCL/OCS
 Handle on rose
Maner cu rozeta

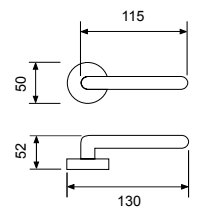

21075P - OCL/OCS
 Handle on plate
Maner cu placa

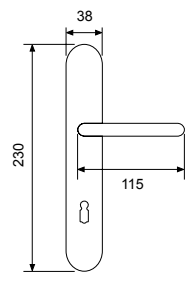

31075DK - OCL/OCS
 Tilt and turn handle
 DK

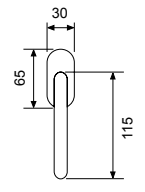



GIULIA



21069R04 - OCS
Handle on rose
Maner cu rozeta

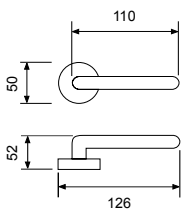

21069P - OCS
Handle on plate
Maner cu placa

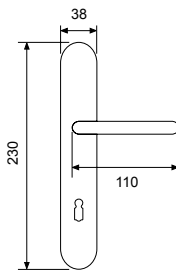

LEFT

RIGHT



31069DK - OCS
Tilt and turn handle
DK

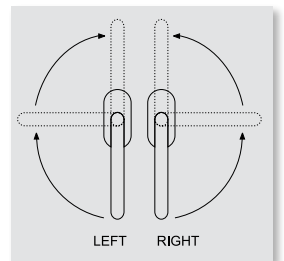
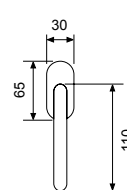

Please specify when is LEFT
Precizati Dreapta sau Stanga



21089R04 - OCS
Handle on rose
Maner cu rozeta

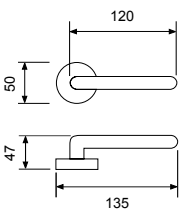

21089P - OCS
Handle on plate
Maner cu placa

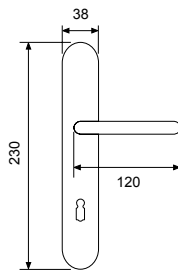

LEFT

RIGHT



31089DK - OCS
Tilt and turn handle
DK

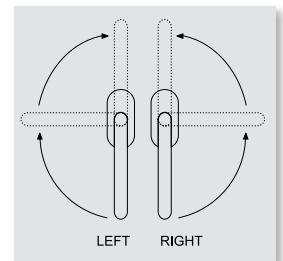
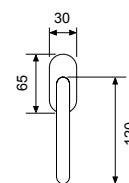

Please specify when is LEFT
Precizati Dreapta sau Stanga



21022R03 - OLV
 Handle on rose
Maner cu rozeta

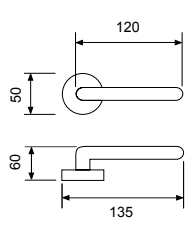

21022P - OLV
 Handle on plate
Maner cu placa

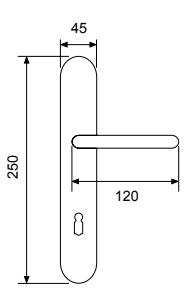

2022 - OLV
 Window's plate on handle
Miner cu sild pt fereastr

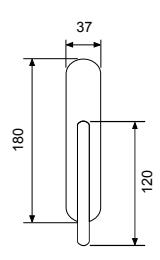

31022DK - OLV
 Tilt and turn handle
DK

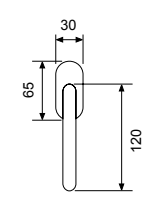



21018R03 - OLV
Handle on rose
Maner cu rozeta

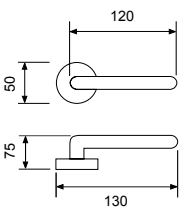

21018P - OLV
Handle on plate
Maner cu placa

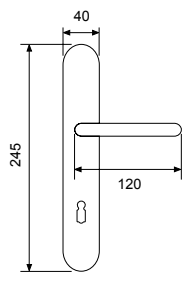

LEFT

RIGHT



31018DK - OLV
Tilt and turn handle
DK

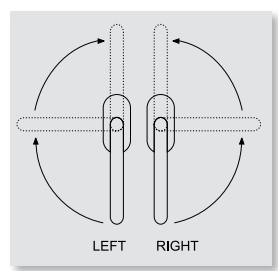
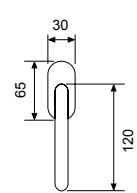

Please specify when is LEFT
Precizati Dreapta sau Stanga



21020R03 - OLV
 Handle on rose
Maner cu rozeta

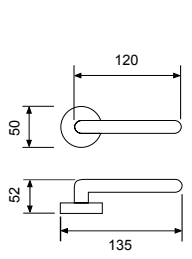

21020P - OLV
 Handle on plate
Maner cu placa

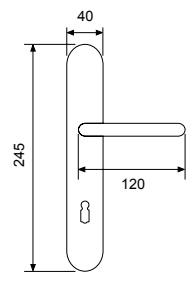

2020 - OLV
 Window handle
Cremon

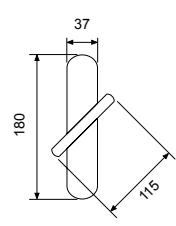

31020DK - OLV
 Tilt and turn handle
DK

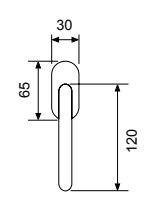



 ISEO

- 
OLV
- 
OBG
- 
OCL
- 
OCS
- 
ONS

21004R03 - OC/OCS
Handle with rcv
Maner cu rozeta filetata

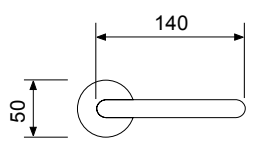

 **BINALIA**[®]





21016R03 - OCS
 Handle on rose
Maner cu rozeta

21016P - OCS
 Handle on plate
Maner cu placa

31016DK - OCS
 Tilt and turn handle
DK

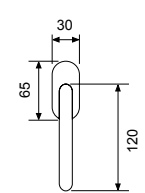
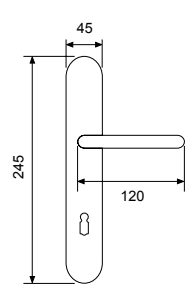
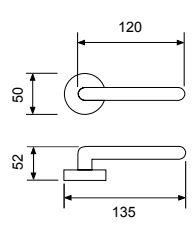



ELEGANT

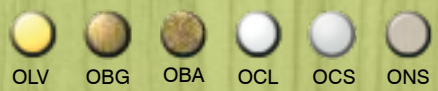

21078R04 - OLV
Handle on rose
Maner cu rozeta

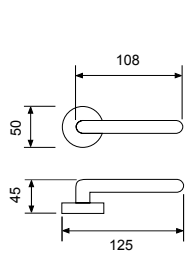

21078P - OLV
Handle on plate
Maner cu placa

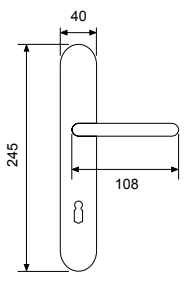

2078 - OLV
Window handle
Cremon

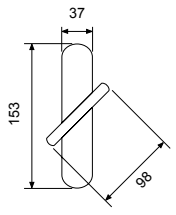

31078DK - OLV
Tilt and turn handle
DK

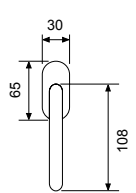

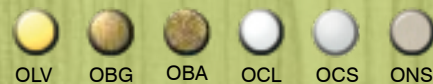

21192R04 - OLV
Handle on rose
Maner cu rozeta

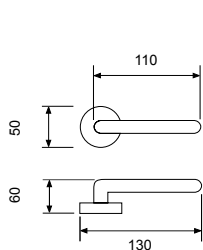

21192P - OLV
Handle on plate
Maner cu placa

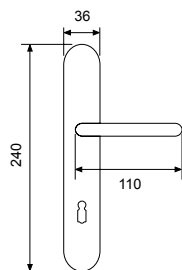

2092 - OLV
Window's plate on handle
Miner cu sild pt fereastr

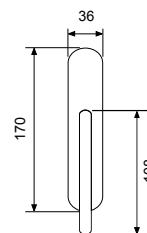

31192DK - OLV
Tilt and turn handle
DK

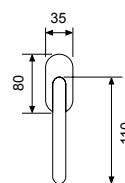

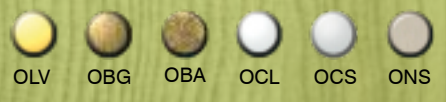

21292R04 - OLV
 Handle on rose
Maner cu rozeta

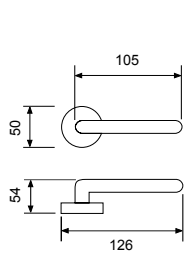

21292P - OLV
 Handle on plate
Maner cu placa

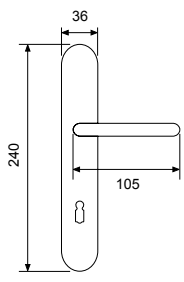

20292 - OLV
 Window handle
Cremon

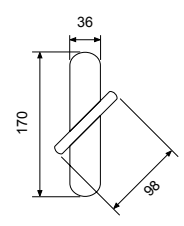

31292DK - OLV
 Tilt and turn handle
DK

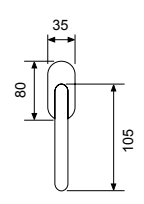

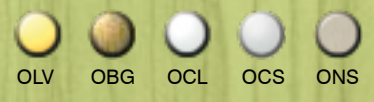

21026R04 - OLV
Handle on rose
Maner cu rozeta

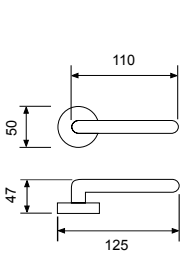

21026P - OLV
Handle on plate
Maner cu placa

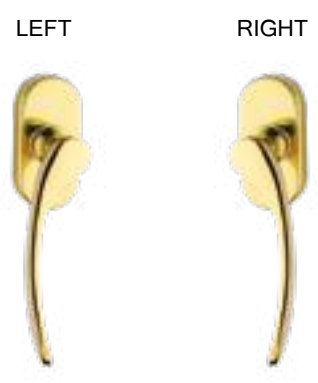
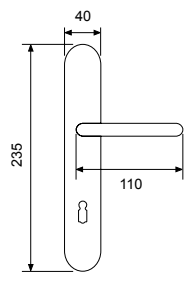

31026DK - OLV
Tilt and turn handle
DK

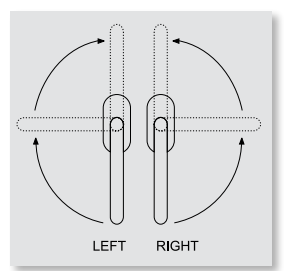
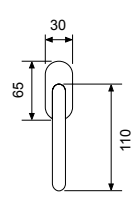

Please specify when is LEFT
Precizati Dreapta sau Stanga



 **CLAUDIA**

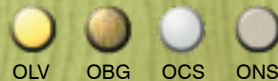

21052R04 - ONS
Handle on rose
Maner cu rozeta

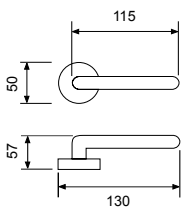

21052P - ONS
Handle on plate
Maner cu placa

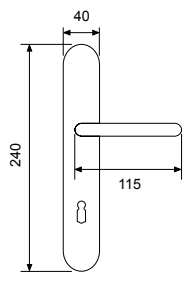

LEFT

RIGHT



31052DK - ONS
Tilt and turn handle
DK

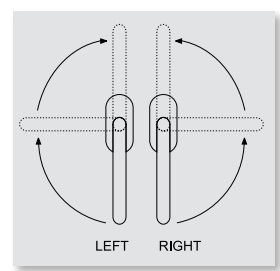
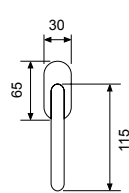

Please specify when is LEFT
Precizati Dreapta sau Stanga



21024R04 - OLV
Handle on rose
Maner cu rozeta

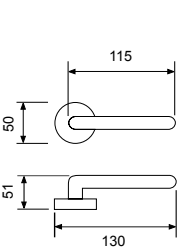

21024P - OLV
Handle on plate
Maner cu placa

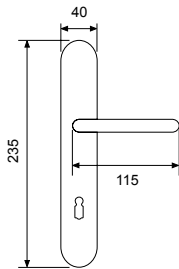

2024 - OLV
Window's plate on handle
Miner cu sild pt fereastr

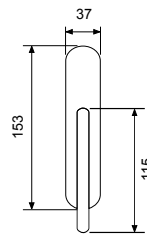

31024DK - OLV
Tilt and turn handle
DK

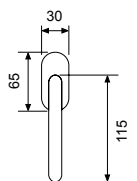



PANDA

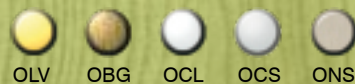

21057R04 - OLV

Handle on rose
Maner cu rozeta

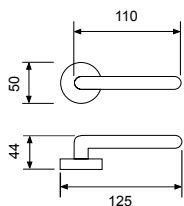

21057P - OLV

Handle on plate
Maner cu placa

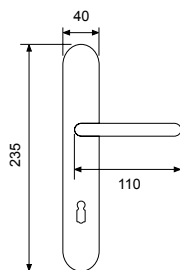

31057DK - OLV

Tilt and turn handle
DK

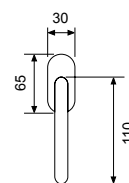



21023R04 - OLV
Handle on rose
Maner cu rozeta

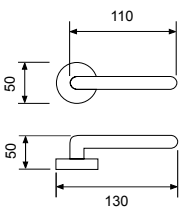

21023P - OLV
Handle on plate
Maner cu placa

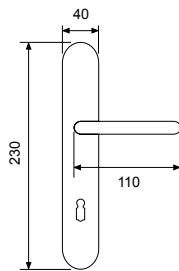

31023DK - OLV
Tilt and turn handle
DK

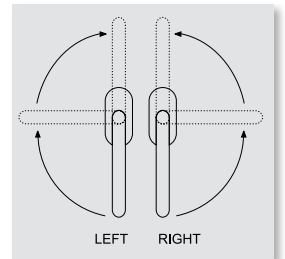
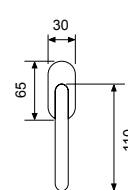

Please specify when is LEFT
Precizati Dreapta sau Stanga

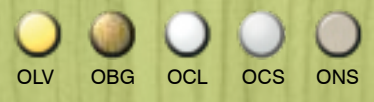

21080R04 - OBG
 Handle on rose
Maner cu rozeta

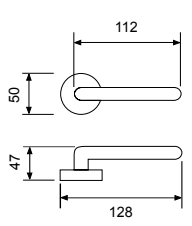

21080P - OBG
 Handle on plate
Maner cu placa

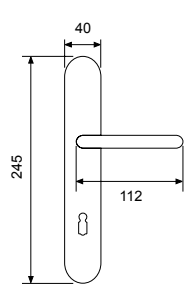

31080DK - OBG
 Tilt and turn handle
DK

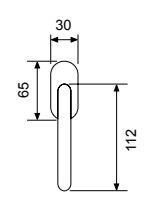



21046R04 - OBV

Handle on rose
Maner cu rozeta

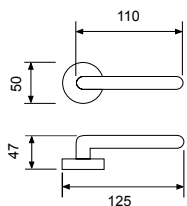

21046P - OBV

Handle on plate
Maner cu placa

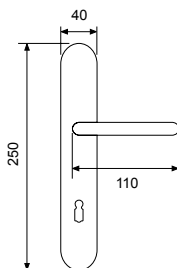

2046 - OBV

Window handle
Cremon

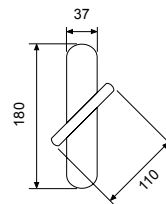



CLARISSA

21048P - OBV

Handle on plate



Maner cu placa

12



OBV

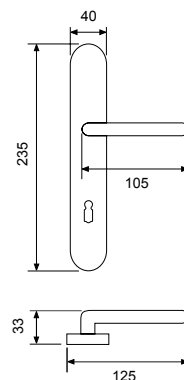

PAPERINO

21044P - OBV

Handle on plate



Maner cu placa

12



OLV



OBV



OBM

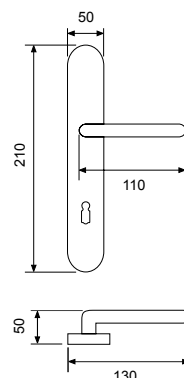

COMBI

21047P - OBV

Handle on plate



Maner cu placa

12



OLV



OBV



OBM

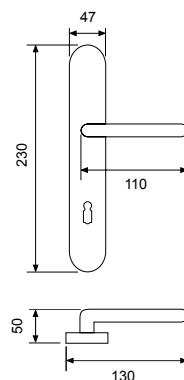



SAFETY SYSTEMS

FOR ARMORED DOORS





LAURA

21015B/1 - OLV

Set for armoured doors:

***21015B/1 CONSISTING IN:

- . BRASS HANDLE
- . BRASS KNOB
- . INTERNAL PROTECTION PLATE HARDENED AND NON / DRILLABLE
- . 2 ANCHORING SCREWS NOT ACCESSIBLE FROM THE OUTSIDE. THE IRON SQUARCAN BE 8*90 OR NIPLEX

Set for armoured doors:

***21015B/1 COMUPUS DIN:

- . MINER DIN ALAMA
- . BUTON DIN ALAMA
- . PLACA DE PROTECTIE CALITA SI NEPERFORABILA
- . 2 SURUBURI MONTAJ NEACCESIBILE DIN EXTERIOR / TIJA METALICE POT FI DE 8*90 SAU NIPLEX



21015P/1 - OCS

Set for armoured doors:

***21015P/1 CONSISTING IN:

- . BRASS HANDLES
- . BRASS PLATES
- . CYLINDER PROTECTION SELF/ADAPTING
- . INTERNAL PROTECTION PLATE HARDENED AND NON / DRILLABLE
- . 2 ANCHORING SCREWS NOT ACCESSIBLE FROM THE OUTSIDE

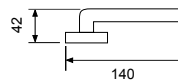
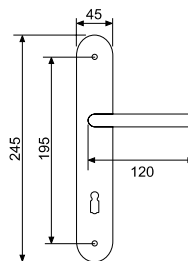

Set for armoured doors:

***21015P/1 COMUPUS DIN:

- . MANERE DIN ALAMA
- . SILD DE ALAMA
- . PASTILA DE PROTECTIE CILINDRU CU AUTOADAPTAREA
- . PLACA DE PROTECTIE CALITA SI NEPERFORABILA
- . 2 SURUBURI MONTAJ NEACCESIBILE DIN EXTERIOR





 **PARIGI**

33812R08 - ZCS

Fixed door-knob

Butoane fix



6

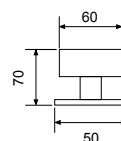

ZCL



ZCS



 **PARIGI DEC**

33812R08/1 - ZCS

Fixed door-knob

Butoane fix



6

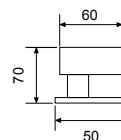

ZCL



ZCS



 **BERLINO**

33811R80 - ZOLV

Fixed door-knob	
<i>Butoane fix</i>	6

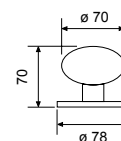

33811R07 - ZOLV

Fixed door-knob	
<i>Butoane fix</i>	6

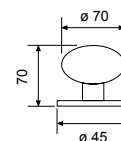

 **VICTORIAN**

31808R03 - OLV

Fixed door-knob	
<i>Butoane fix</i>	6

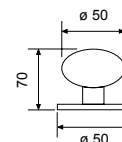

 **BERLINO**

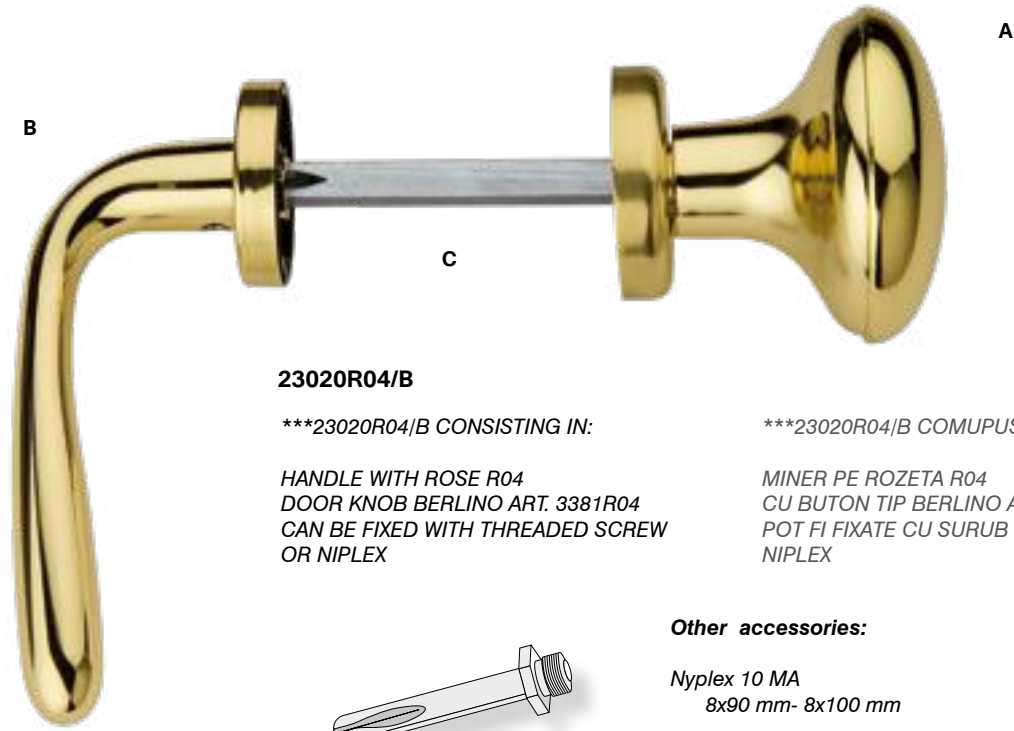

23020R04/B

***23020R04/B CONSISTING IN:
 HANDLE WITH ROSE R04
 DOOR KNOB BERLINO ART. 3381R04
 CAN BE FIXED WITH THREADED SCREW
 OR NIPLEX

***23020R04/B COMUPUS DIN:
 MINER PE ROZETA R04
 CU BUTON TIP BERLINO ART. 3381R04
 POT FI FIXATE CU SURUB FILETAT SAU
 NIPLEX

Other accessories:

Nyplex 10 MA
 8x90 mm- 8x100 mm

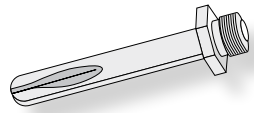

 **BLINDO**

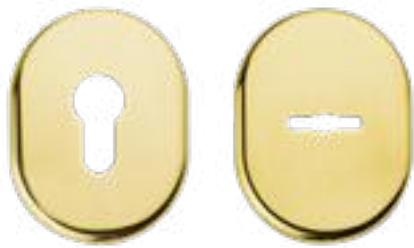

B50Y
62X82 mm

B50DM
62X82 mm

 **DEFENDER**



B52Y
ø 52 mm - h 12 mm



TECHNICAL DRAWING TO FIX / INSTRUCIUNI TEHNICE PENTRU FIXARE

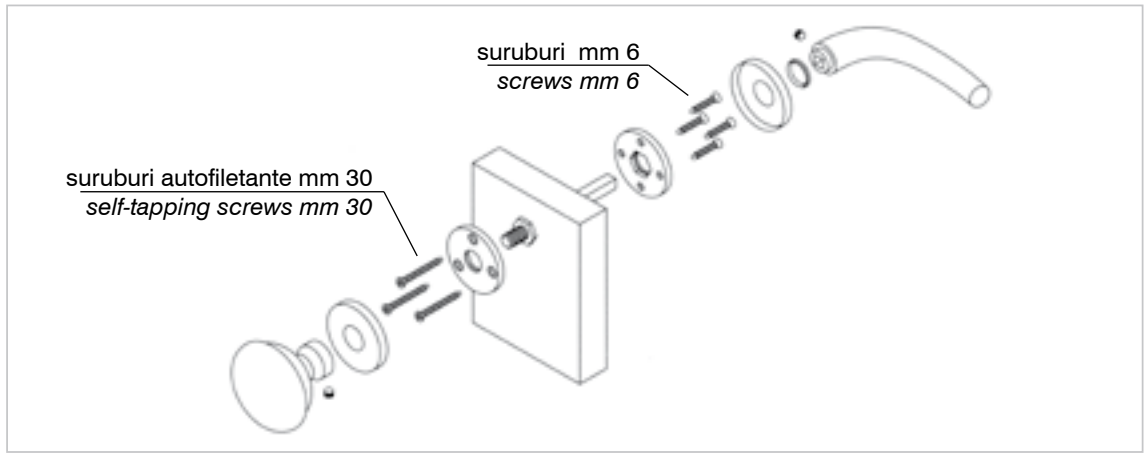

BRASS PULL-HANDLES

MANERE TRAGATOARE DIN ALAMA



MANHATTAN

23082T - OCS

Pull-handle	
Manere tragatoare	1

	A	B
23082T	200	230
28082T	250	280
33082T	300	330
48082T	450	480



ELISA

31581T - OCS

Pull-handle	
Manere tragatoare	1

	A	B
31581T	160	180
31582T	200	220

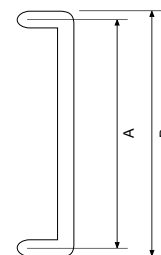

BRASS PULL-HANDLES
 MANERE TRAGATOARE DIN ALAMA



 **LUCIA**

31507T - OCL/OCS

Pull-handle	
Manere tragatoare	1

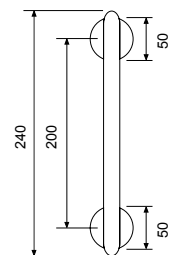

 **GARDA**

31510T - OCL/OCS

Pull-handle	
Manere tragatoare	1

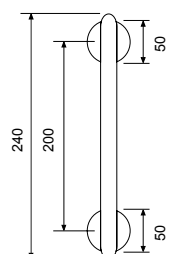

BRASS PULL-HANDLES
MANERE TRAGATOARE DIN ALAMA



315200T - OLV

Pull-handle



Manere tragatoare

1



OLV



OBG



OBA

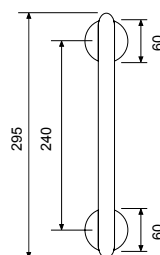

BRASS PULL-HANDLES
 MANERE TRAGATOARE DIN ALAMA



 **GRANADA**

31518T - OLV

Pull-handle	
Manere tragatoare	1

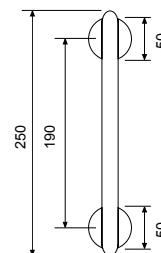

 **MADRID**

31532T - OLV

Pull-handle	
Manere tragatoare	1

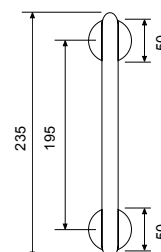

STAINLESS STEEL PULL-HANDLES
 MANERE TRAGATOARE DIN OTEL INOXIDABIL



 **DELTA**

 **GAMMA**

34502T - INOX SAT

Pull-handle



Manere tragatoare | 1

 INOX SAT

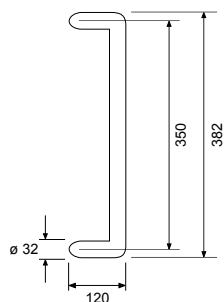

34503T - INOX SAT

Pull-handle



Manere tragatoare | 1

 INOX SAT

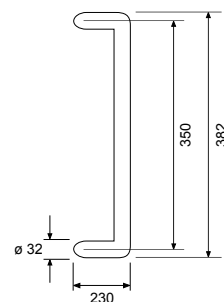

STAINLESS STEEL PULL-HANDLES
 MANERE TRAGATOARE DIN OTEL INOXIDABIL

ACCESSORIES LINE SERIA ACCESORII ACCESSORIES LINE SERIA ACCESORII

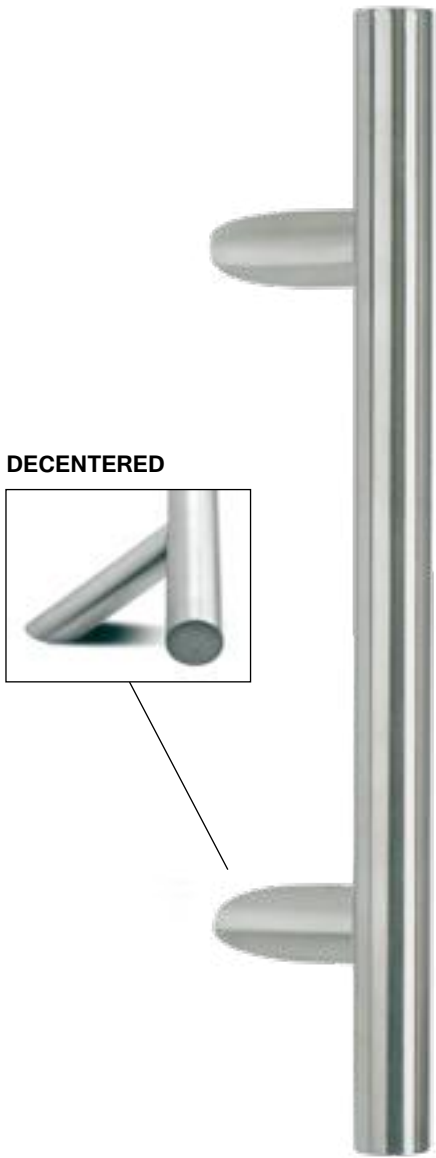

 **THEMA**

34506T/D - INOX SAT

Pull-handle 
 Manere tragatoare | 1

	A	B	C	H
34506T/D	300	460	45	80
36506T/D	500	660	45	80
36116T/D	1000	1160	45	80

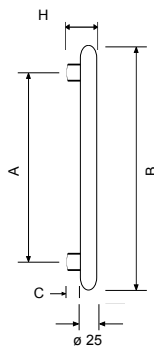

 **SIGMA**

34507T/D - INOX SAT

Pull-handle 
 Manere tragatoare | 1

	A	B
34507T/D	210	300
34507T/D	300	400
36507T/D	300	500
36507T/D	400	600
36517T/D	600	800
36517T/D	900	1200

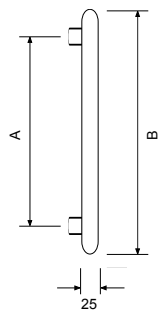



ROBY

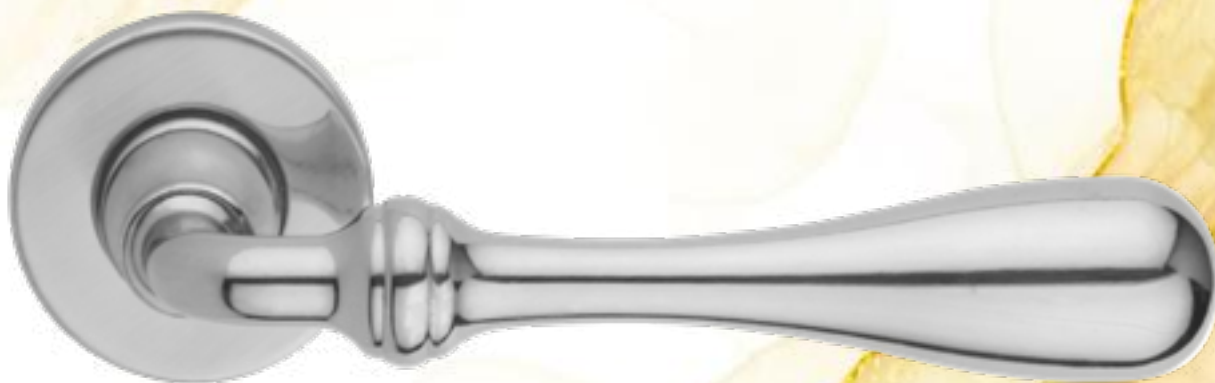

23087R07 - OC/OCS

Handle with rcv

Maner cu rozeta filetata

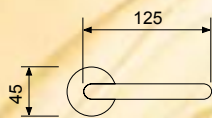



MARGARET



23040R03 - ZCL/ZCS



23040R04 - ZCS



23040R04 - ZCL



CARINA

- ZOLV
- ZBG
- ZCL
- ZCS
- ZNS



23066R04 - ZCS

Handle on rose
Maner cu rozeta

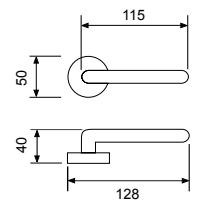

23066PF - ZCS

Handle on plate
Maner cu placa

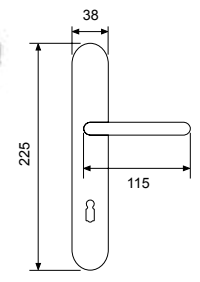

33066DK - ZCS

Tilt and turn handle
DK

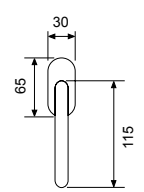



MAREA



23062R04 - ZCS
Handle on rose
Maner cu rozeta

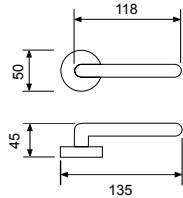

33062DK - ZCS
Tilt and turn handle
DK

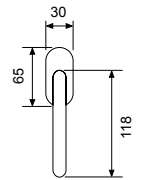

MONICA



23050R04 - ZCS
Handle on rose
Maner cu rozeta

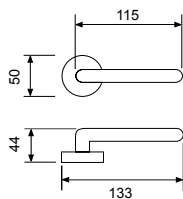

33050DK - ZCS
Tilt and turn handle
DK

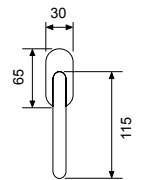



AMBRA ECO

- 
ZOLV
- 
ZBG
- 
ZCL
- 
ZCS
- 
ZNS



23079R04 - ZC
Handle with rpl
Maner cu rozeta rpl

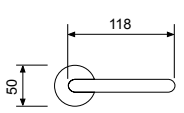

23079PF - ZCS
Handle with plate
Maner cu placa

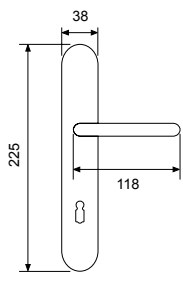

33079DK - ZC
Tilt and turn handle
DK

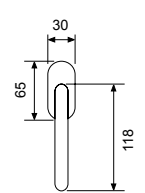



 **BETA ECO**



23024R04 - ZCL
 Handle on rose
Maner cu rozeta

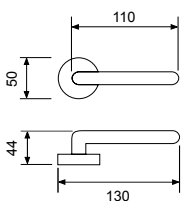

23024PF - ZCS
 Handle on plate
Maner cu placa

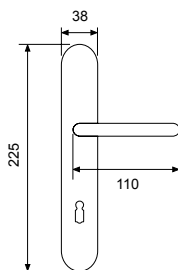

33024DK - ZCL
 Tilt and turn handle
DK

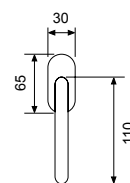



23072R04 - ZCS

Handle on rose
Maner cu rozeta

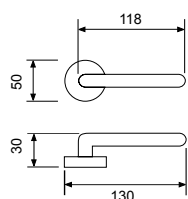

23072PF - ZCS

Handle on plate
Maner cu placa

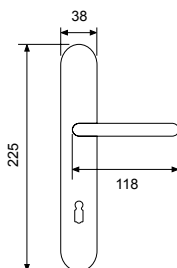

33072DK - ZCS

Tilt and turn handle
DK

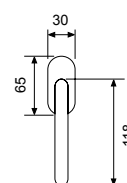



AMBRA ECO MINUS



23079MR04 - ZCL

Handle on rose
Maner cu rozeta

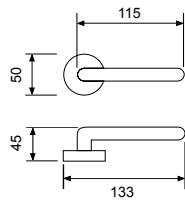

23079MR06 - ZCL

Handle on rose
Maner cu rozeta

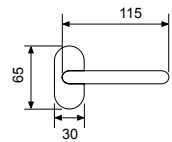

VIENNETTA ECO



23026R04 - ZCL

Handle on rose
Maner cu rozeta

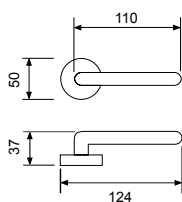

33026DK - ZCL

Tilt and turn handle
DK

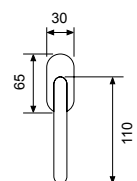



SOFIA

ZCL/ZNS



22001R23 - ZCL/ZNS

Handle on rose
Maner cu rozeta

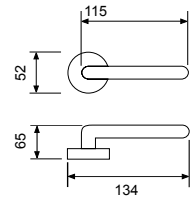

RIO

ZCL/ZNS



22002R23 - ZCL/ZNS

Handle on rose
Maner cu rozeta

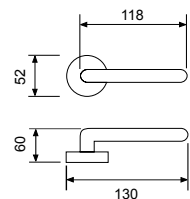



 **VENERA**



ALLUMINIUM LINE SERIA ALUMINIU



22063R04 - F4
Handle on rose
Maner cu rozeta

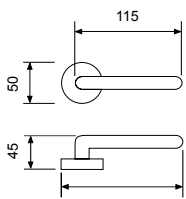

22063P - F4
Handle on plate
Maner cu placa

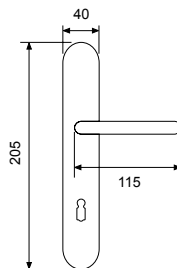

32063DK - F4
Tilt and turn handle
DK

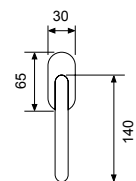

ALLUMINIUM LINE SERIA ALUMINIU



MURES



25115R04 - F6
Handle on rose
Maner cu rozeta

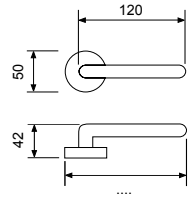

25115P - F6
Handle on plate
Maner cu placa

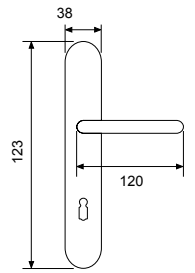

ARAD



25150R04 - F6
Handle on rose
Maner cu rozeta

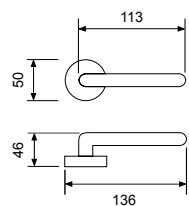

25150P - F6
Handle on plate
Maner cu placa

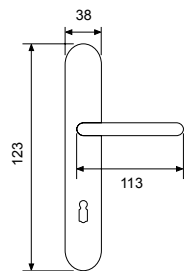



25164P

25164P - RAL 9016

Handle on plate



Maner cu placa

25



RAL 9016 RAL 8022 F5 F6

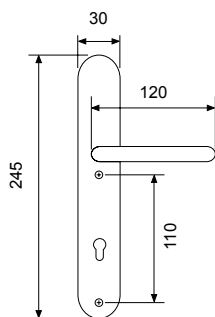



NOVANTA

INOX SAT



24071R05 - INOX SAT

Handle on rose
Maner cu rozeta

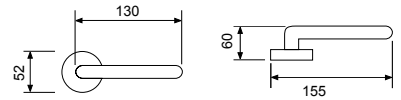

U

INOX SAT



1072R05 - INOX SAT

Handle on rose
Maner cu rozeta

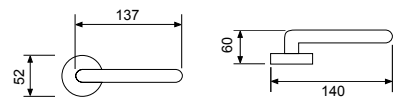

OLIVA



33815R04 - ZOL

Knob on rose for opening limiting device



Buton limitare deschidere usa

30

ø 50 mm

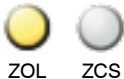

ZOL ZCS

FRANCESE



33812R12 - ZCS

Knob on rose for opening limiting device



Buton limitare deschidere usa

30

30x65 mm



ZCS

NAPOLEONE



33814R12 - ZCS

Knob on rose for opening limiting device



Buton limitare deschidere usa

30

30x65 mm



ZCS

ELEGANT

▶ page 41

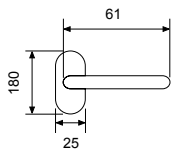

31078OL - OLV

Half handle on oliver rose



Oliver

30

AMBRA

▶ page 37

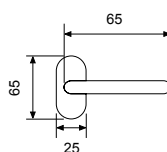

31020OL - OLV

Half handle on oliver rose



Oliver

30

GRANADA

▶ page 36

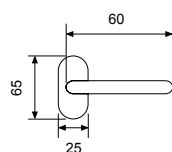

31022OL - OLV

Half handle on oliver rose



Oliver

30

WIEN

▶ page 43

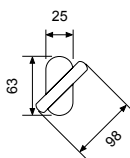

31192S - OLV

Window handle on oliver rose



Oliver T

30

WIEN

▶ page 43

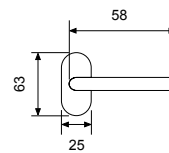

31192OL - OLV

Half handle on oliver rose



Oliver

30



OLV OBG OCL OCS ONS

WINDOW'S ACCESSORIES ACCESORII PENTRU FERESTRE

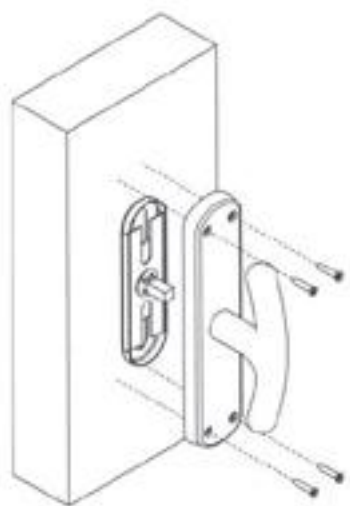

153x37 mm



170x36 mm



180x37 mm



153x37 mm

ELEGANT

▶ page 41

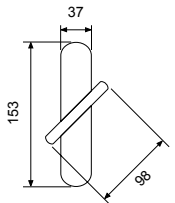

2078 - OLV

Window handle	
Cremon	12

TOLOSA

▶ page 26

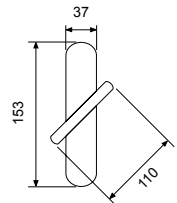

2058 - OGR

Window handle	
Cremon	12

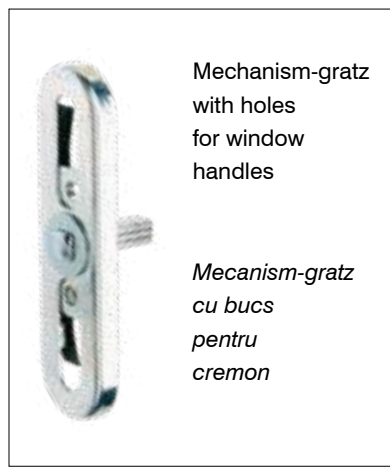

WIEN

▶ page 43

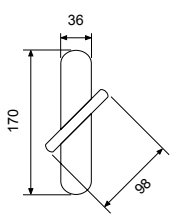

2092 - OLV

Window handle	
Cremon	12

AMBRA

▶ page 37

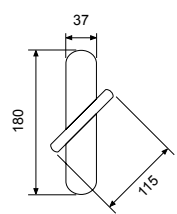

2020 - OLV

Window handle	
Cremon	12

SIMONA

▶ page 50

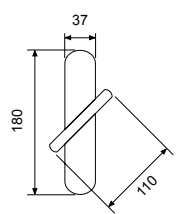

2046 - OBV

Window handle	
Cremon	12

DIFFERENT COMPLEMENTS
DIFERITE COMPONENTE



 **LEU**

31703 - OLV

Knocker

Batatoare



25

180x120 mm



OLV OBG

31704 - OLV

Knocker

Batatoare



25

120x90 mm



OLV OBG



4001 - OLV

Cover roller

Role de acoperire



25

240x55 mm



OLV OBG OCS OCL



4002 - OLV

Cover roller

Role de acoperire



25

260x58 mm



OLV OBG OCS OCL

DIFFERENT COMPLEMENTS
DIFERITE COMPONENTE



31600L/2 - OLV

Small brass letters <i>Litere mici din alama</i>	
	25

50x38 mm



31600N/1 - OLV

Big brass numerals <i>Numere mari din alama</i>	
	25

125x73 mm



31600N/2 - OLV

Small brass numerals <i>Numere mici din alama</i>	
	25

75x40 mm



31601 - OLV

Doors stop <i>Opritoare usi</i>	
	150

ø 45 mm



31602 - OLV

Doors stop <i>Opritoare usi</i>	
	150

35x27 mm



ROSES - TOILET ROSES - ESCUTHCCEONS
 ROZETA - ROZETA WC - BOCHETTA

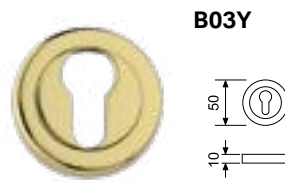
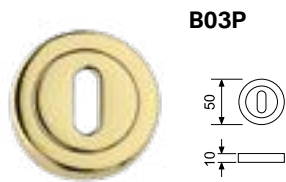
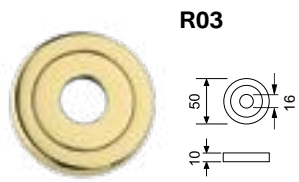

R03WC

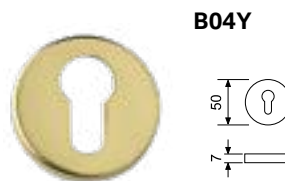
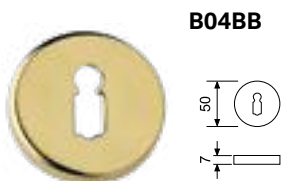
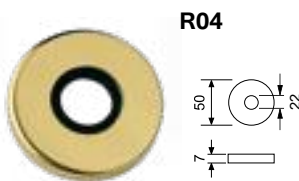
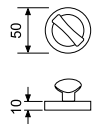
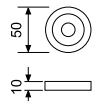

R04WC

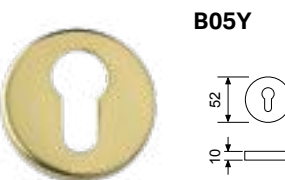
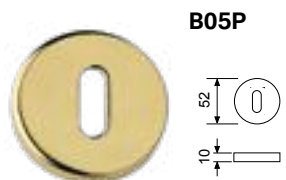
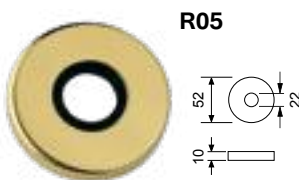
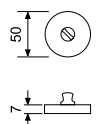
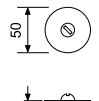

R05WC

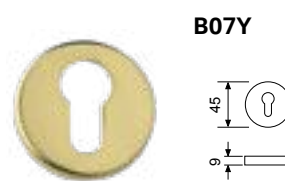
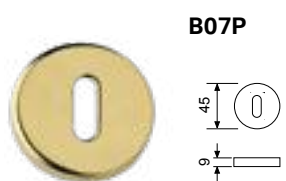
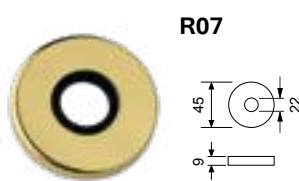
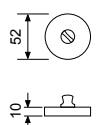
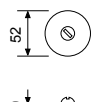

R07WC

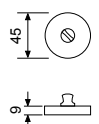
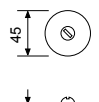

ACCESSORIES LINE SERIA ACCESSORII ACCESSORIES LINE SERIA ACCESSORII

ROSES - TOILET ROSES - ESCUTCHIONS
 ROZETA - ROZETA WC - BOCHETTA

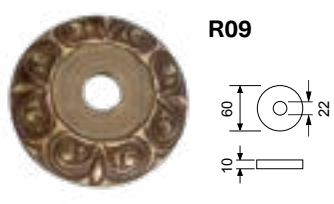

R09

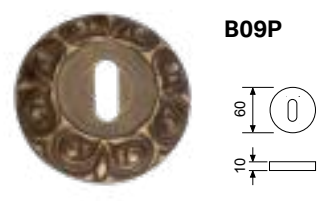

B09P

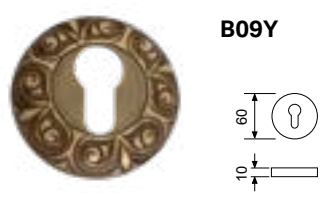

B09Y

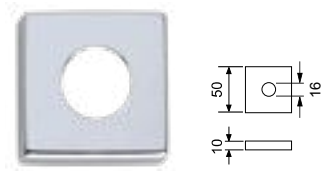

R08 F/Z

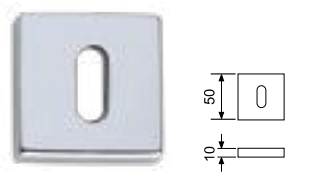

B08P F/Z

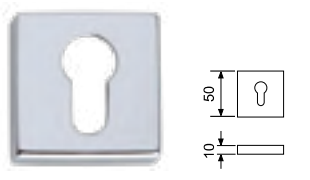

B08Y F/Z

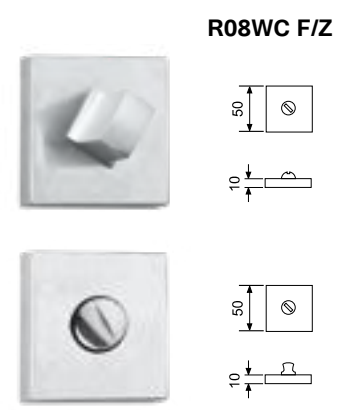

R08WC F/Z

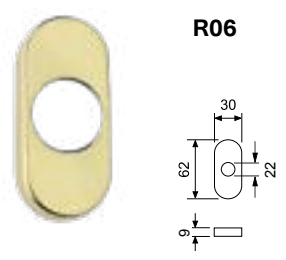

R06

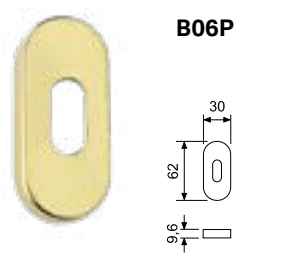

B06P

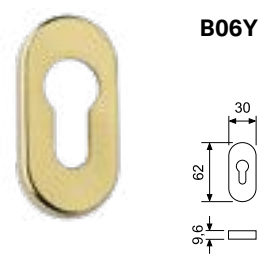

B06Y

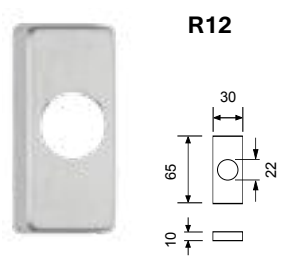

R12

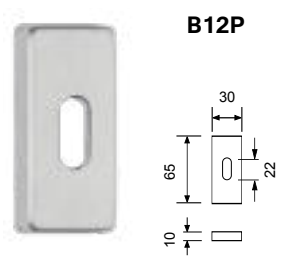

B12P

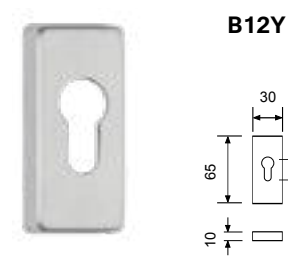

B12Y

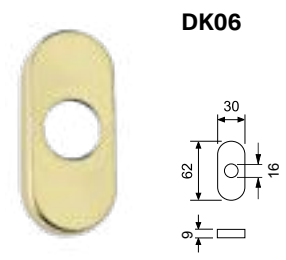

DK06

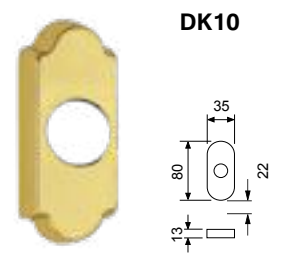

DK10

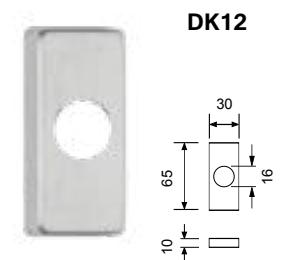

DK12



DK06 SECURITY





Verofer[®]

**Cylinders and
Complements**



VEROFER

BINALIA



Verofer®

BINALIA®



“A businessman is both a pioneer and an inventor, he acts with bravery, he is able to loose with dignity, but he is able to start again with enthusiasm.”

“Un om de afaceri este deopotrivă un pionier și un inventator, actionează cu curaj, este capabil să piardă cu demnitate, dar este întotdeauna în stare să reînceapă cu entuziasm.”

GIROLAMO VERCELLINI
Founder Verofer srl

REGISTRATION CERTIFICATE

This is to certify that the management system of

SC VEROFER SRL

has been assessed by AIA EUROPE and registered against the requirements of

ISO 9001:2015

AJAEU/12/12739

12th June 2012

Initial Issue

First of Full-time Registration

10th May 2024

24th May 2021

Renewal Date

End of the Registration

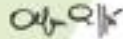

Alfonso Pagliuca, President & Founder, AIA Europe Ltd



REGISTRATION SCHEDULE

scope of registration

Produce si comercializare produse din fieronerie (din alama), inclusiv activitati aferente de proiectare.
Manufacture and sale of ironmongery (from brass), including related design activities.

SC BINALIA SRL

Registration Date

Str. 8 Martie nr 51-53, Localitate Arad, Judet Arad, Romania

17

AJAEU/12/12731

31st May 2012

24th May 2021

11th May 2024

Date of Initial Registration

Date of Re-registration

Renewal Date

11th March 2024

N/A

11th May 2021

Next Re-Audit Due Date

Registration Date

Previous Issue Date

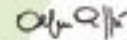

Alfonso Pagliuca, President & Founder, AIA Europe Ltd

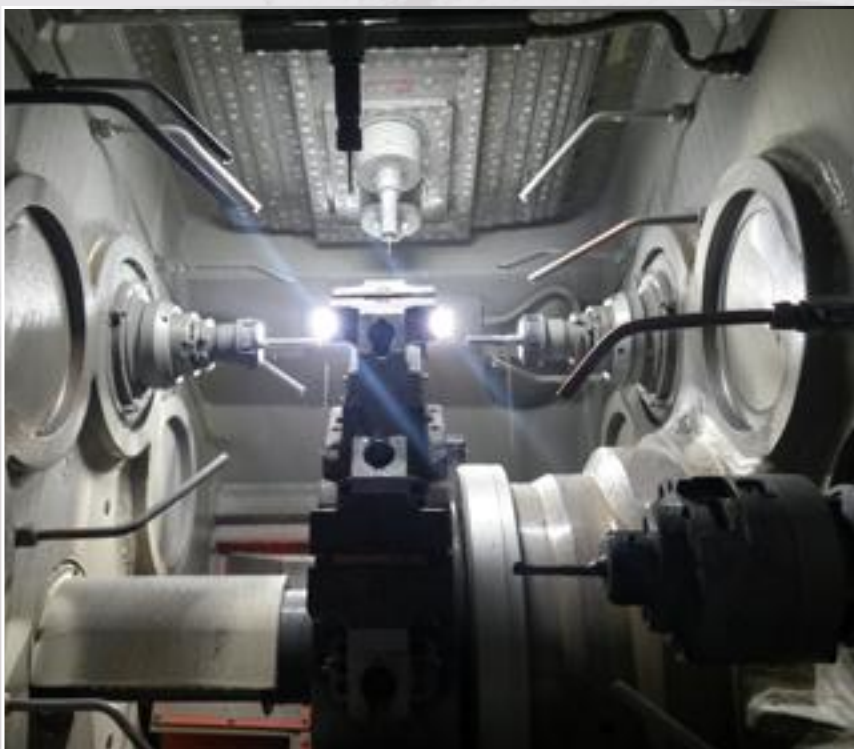

Verofer®

**Cylinders and
Complements**

IMP INSTITUTE OF PRECISION MECHANICS
 CERTIFICATION DEPARTMENT
 01-796 Warszawa, ul. Duchnicka 3
 phone 22 663-43-24, 22 560-28-00 e-mail: marek.zetala@imp.edu.pl
 http://www.imp.edu.pl/pcert

PCA
 Polish Centre for Accreditation
 AC 041

CERTIFICATE OF CONFORMITY

No. P41/374/2016 (6955)
 ENGLISH EDITION

Name and address of the certificate owner:
VEROFER SRL
 Calea 6 Vanatori nr 51/53, 310162 Romania

Name and address of the manufacturer:
VEROFER SRL
 Calea 6 Vanatori nr 51/53, 310162 Romania

Product name:
Profile cylinder

Type (variants):
 Căndru de siguranță din alama
 Căndru de siguranță din alama nichelat
 Căndru de siguranță din alama butonichei
 Căndru de siguranță din alama butonichei nichelat
 Semicăndru de siguranță din alama
 Semicăndru de siguranță din alama nichelat

Main features: Class of protection: - 4 - acc. to PN-EN 1303:2015-07

Class of protection:

Category of use	No. of test cycles durability	Door mass	Fire resistance	Safety in use	Corrosion resistance	Protection requirements	Abuse resistance
1	6	0	0	0	C	4	0

The product fulfills requirements of:
PN-EN 1303:2015-07

Date of expiration and certificate validity conditions: **October 11, 2019**

This certificate is valid from **October 12, 2016** until **October 11, 2019** only for products covered by application No. 158/NR/2016, provided that the technical specification is valid, item fulfills its requirements and there were no major changes in: product type, system, conditions and the place of the production

Certification of conformity Type „Z” acc. to PN-EN ISO/IEC 17067:2014-01.
 Certificate of conformity issued acc. to the program PC-03 (88P)

MANAGER
 CERTIFICATION DEPARTMENT

 Marek ZETALA M.Sc., Eng.

DIRECTOR
 INSTITUTE OF PRECISION MECHANICS

 Tomasz BABUL, Ph.D., D.Sc., Eng. prof. IMP

Certificate can be published only by Certificate Owner without comments, abbreviations and changes.
 Warsaw, October 12, 2016.

INSTITUTE OF PRECISION MECHANICS
 Form No. F-2.2.1, edition 5, Mar 20, 2016

All our brass cylinders are produced under the UNI EN 1303 : 2015 - 07 norm

Cilindri Verofer sunt realizati din alama respectand standardul UNI EN 1303 : 2015 - 07 norm



EUROPEAN PROFILE CYLINDERS
CILINDRI PROFIL EUROPEAN



Cylinders are in brass supplied with:

- . 3 brass nichel keys
- . cam UNI or DIN
- . fixing screw M 5x60

Cilindri sunt dotati cu:

- . 3 chei din alama nichelate
- . paleta UNI sau DIN
- . surub M 5x60

Paleta UNI

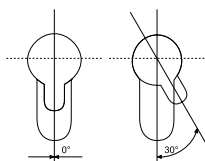

Paleta DIN

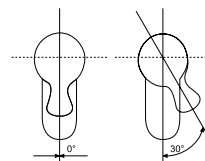

CODE <i>COD</i>	A	B mm.	L	PINS <i>Nr. Stifturi</i>	1 PCS EACH BOX <i>Buc/cutie</i>	50 PCS EACH CARTON <i>Buc/bax</i>
110520	26	26	52	8	1	50
110561	26	30	56	8	1	50
110600	30	30	60	12/10	1	50
110601	25	35	60	8	1	50
110651	30	35	65	12/10	1	50
110700	35	35	70	12/10	1	50
110701	30	40	70	12/10	1	50
110751	35	40	75	12/10	1	50
110752	30	45	75	12/10	1	50
110800	40	40	80	12/10	1	50
110801	30	50	80	12/10	1	50
110802	35	45	80	12/10	1	50
110851	35	50	85	12/10	1	50
110852	40	45	85	12/10	1	50
110900	45	45	90	12/10	1	50
110901	35	55	90	12/10	1	50
110902	40	50	90	12/10	1	50
110903	30	60	90	12/10	1	50
110951	40	55	95	12/10	1	50
110952	45	50	95	12/10	1	50
110953	30	65	95	12/10	1	50
110954	35	60	95	12/10	1	50
111000	50	50	100	12/10	1	50
111001	45	55	100	12/10	1	50
111002	35	65	100	12/10	1	50
111051	45	60	105	12/10	1	50
111052	50	55	105	12/10	1	50
111101	45	65	110	12/10	1	50
111102	50	60	110	12/10	1	50
111151	50	65	115	12/10	1	50

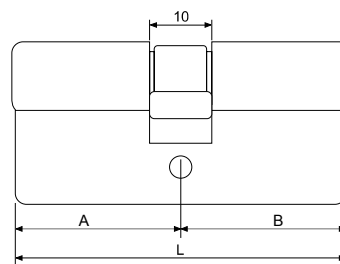
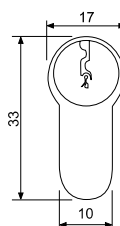



SECURITY CYLINDERS WITH REVERSIBLE KEYS CILINDRI DE SIGURANTA CU CHEI REVERSIBILE



Cylinders are in brass supplied with:

- . 4 brass nickel keys
- . cam UNI or DIN
- . fixing screw M 5x60

Cilindri sunt dotati cu:

- . 4 chei din alama nichelate
- . paleta UNI sau DIN
- . surub M 5x60

Paleta UNI

Paleta DIN

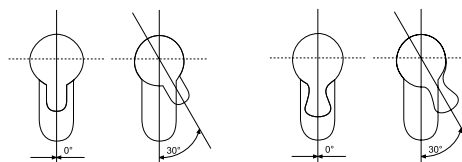

CODE <i>COD</i>	A	B mm.	L	PINS <i>Nr. Stifturi</i>	1 PCS EACH BOX <i>Buc/cutie</i>	50 PCS EACH CARTON <i>Buc/bax</i>
110600A	30	30	60	12/10	1	50
110651A	30	35	65	12/10	1	50
110700A	35	35	70	12/10	1	50
110701A	30	40	70	12/10	1	50
110751A	35	40	75	12/10	1	50
110752A	30	45	75	12/10	1	50
110800A	40	40	80	12/10	1	50
110801A	30	50	80	12/10	1	50
110802A	35	45	80	12/10	1	50
110851A	35	50	85	12/10	1	50
110852A	40	45	85	12/10	1	50
110900A	45	45	90	12/10	1	50
110901A	35	55	90	12/10	1	50
110902A	40	50	90	12/10	1	50
110903A	30	60	90	12/10	1	50
110951A	40	55	95	12/10	1	50
110952A	45	50	95	12/10	1	50
111000A	50	50	100	12/10	1	50
111001A	45	55	100	12/10	1	50
111051A	45	60	105	12/10	1	50
111052A	50	55	105	12/10	1	50
11102A	50	60	110	12/10	1	50

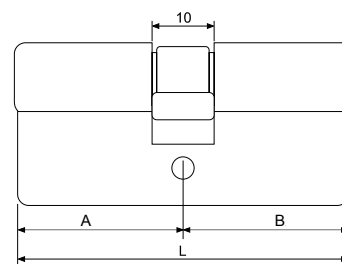
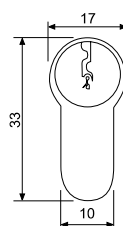



BATHROOM CYLINDERS & THUMBTURN CILINDRI CU BUTON PENTRU BAIE



Cylinders are in brass supplied with:

- . cam UNI or DIN
- . fixing screw M 5x60

Cilindri sunt dotati cu:

- . paleta UNI sau DIN
- . surub M 5x60

Paleta UNI

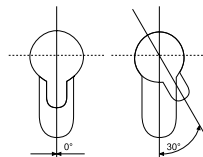

Paleta DIN

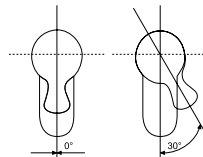

CODE <i>COD</i>	A	B mm.	L	PINS <i>Nr. Stifturi</i>	1 PCS EACH BOX <i>Buc/cutie</i>	50 PCS EACH CARTON <i>Buc/bax</i>
110520W	26	26	52	-	1	50
110561WL	26	30	56	-	1	50
110561WS	30	26	56	-	1	50
110600W	30	30	60	-	1	50
110601WL	25	35	60	-	1	50
110601WS	35	25	60	-	1	50
110651WL	30	35	65	-	1	50
110651WS	35	30	65	-	1	50
110700W	35	35	70	-	1	50
110701WL	30	40	70	-	1	50
110701WS	40	30	70	-	1	50
110751WL	35	40	75	-	1	50
110751WS	40	35	75	-	1	50
110800W	40	40	80	-	1	50
110801WL	30	50	80	-	1	50
110801WS	50	30	80	-	1	50
110802WL	35	45	80	-	1	50
110802WS	45	35	80	-	1	50
110851WL	35	50	85	-	1	50
110851WS	50	35	85	-	1	50
110852WL	40	45	85	-	1	50
110852WS	45	40	85	-	1	50
110900W	45	45	90	-	1	50
110901WL	35	55	90	-	1	50
110901WS	55	35	90	-	1	50
110902WL	40	50	90	-	1	50
110902WS	50	40	90	-	1	50
110951WL	40	55	95	-	1	50
110951WS	55	40	95	-	1	50
110952WL	45	50	95	-	1	50
110952WS	50	45	95	-	1	50
111000W	50	50	100	-	1	50
111001WL	45	55	100	-	1	50
111001WS	55	45	100	-	1	50
111051WL	45	60	105	-	1	50
111051WS	60	45	105	-	1	50
111101WS	65	45	110	-	1	50
111102WL	50	60	110	-	1	50
111102WS	60	50	110	-	1	50

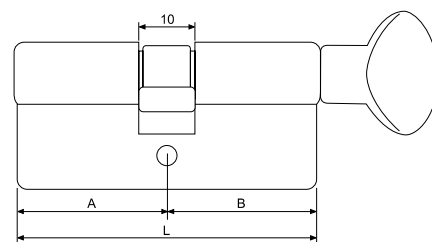
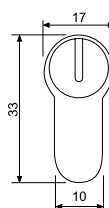



CYLINDERS WITH THUMBTURN & 3 KEYS CILINDRI CU BUTON & CHEI



Cylinders are in brass supplied with:

- . 3 brass nichel keys
- . cam UNI or DIN
- . fixing screw M 5x60

Cilindri sunt dotati cu:

- . 3 chei din alama nichelate
- . paleta UNI sau DIN
- . surub M 5x60

Paleta UNI

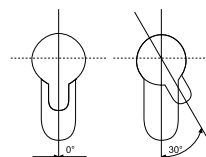

Paleta DIN

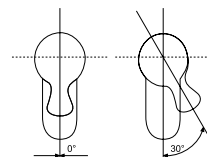

CODE <i>COD</i>	A	B mm.	L	PINS <i>Nr. Stifturi</i>	1 PCS EACH BOX <i>Buc/cutie</i>	50 PCS EACH CARTON <i>Buc/bax</i>
110520B	26	26	52	4	1	50
110561BL	26	30	56	4	1	50
110561BS	30	26	56	4	1	50
110600B	30	30	60	5	1	50
110601BL	25	35	60	4	1	50
110601BS	35	25	60	5	1	50
110651BL	30	35	65	5	1	50
110651BS	35	30	65	5	1	50
110700B	35	35	70	5	1	50
110701BL	30	40	70	5	1	50
110701BS	40	30	70	5	1	50
110751BL	35	40	75	5	1	50
110751BS	40	35	75	5	1	50
110800B	40	40	80	5	1	50
110801BL	30	50	80	5	1	50
110801BS	50	30	80	5	1	50
110802BL	35	45	80	5	1	50
110802BS	45	35	80	5	1	50
110851BL	35	50	85	5	1	50
110851BS	50	35	85	5	1	50
110852BL	40	45	85	5	1	50
110852BS	45	40	85	5	1	50
110900B	45	45	90	5	1	50
110901BL	35	55	90	5	1	50
110901BS	55	35	90	5	1	50
110902BL	40	50	90	5	1	50
110902BS	50	40	90	5	1	50
110951BL	40	55	95	5	1	50
110951BS	55	40	95	5	1	50
110952BL	45	50	95	5	1	50
110952BS	50	45	95	5	1	50
111000B	50	50	100	5	1	50
111001BL	45	55	100	5	1	50
111001BS	55	45	100	5	1	50
111051BL	45	60	105	5	1	50
111051BS	60	45	105	5	1	50
111102BL	50	60	110	5	1	50
111102BS	60	50	110	5	1	50

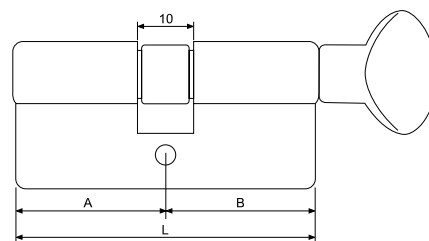
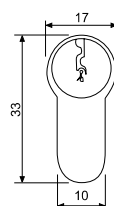



SINGLE CYLINDERS & THUMBTURN
 SEMICILINDRI CU BUTON



Cylinders are in brass supplied with:

- . cam UNI or *DIN*
- . fixing screw M 5x60

Cilindri sunt dotati cu:

- . *paleta UNI sau DIN*
- . *surub M 5x60*

Paleta UNI

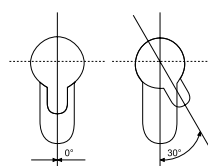

Paleta DIN

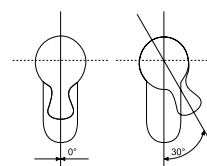

CODE <i>COD</i>	A	B mm.	L	PINS <i>Nr. Stifturi</i>	1 PCS EACH BOX <i>Buc/cutie</i>	100 PCS EACH CARTON <i>Buc/bax</i>
110401BL	10	30	40	-	1	50
110451BL	10	35	45	-	1	50
110501BL	10	40	50	-	1	50

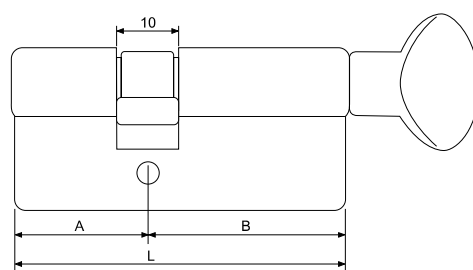
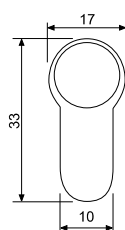

BRASS-01 NIKEL-02





SINGLE CYLINDERS & KEYS SEMICILINDRI & CHEI



Cylinders are in brass supplied with:

- . 3 brass nichel keys
- . cam UNI or DIN
- . fixing screw M 5x60

Cilindri sunt dotati cu:

- . 3 chei din alama nichelate
- . paleta UNI sau DIN
- . surub M 5x60

Paleta UNI

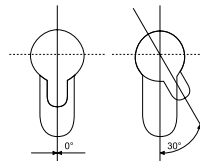

Paleta DIN

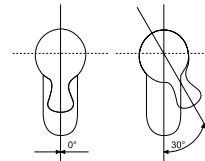

CODE <i>COD</i>	A	B mm.	L	PINS <i>Nr. Stifturi</i>	1 PCS EACH BOX <i>Buc/cutie</i>	100 PCS EACH CARTON <i>Buc/bax</i>
110351	10	25	35	4	1	50
110401	10	30	40	5	1	50
110451	10	35	45	5	1	50
110501	10	40	50	5	1	50

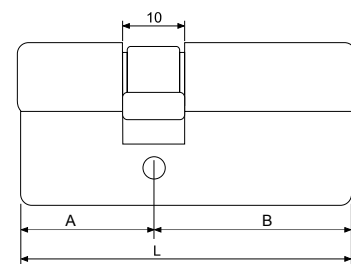
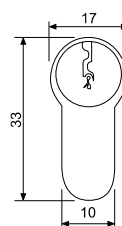

BRASS-01



NIKEL-02



Master key

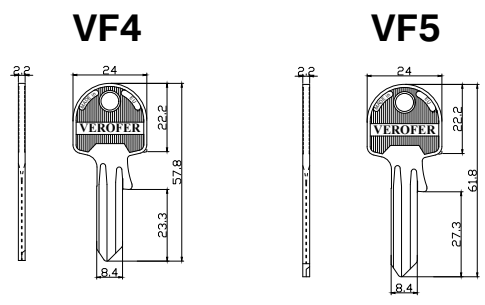
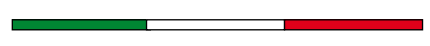
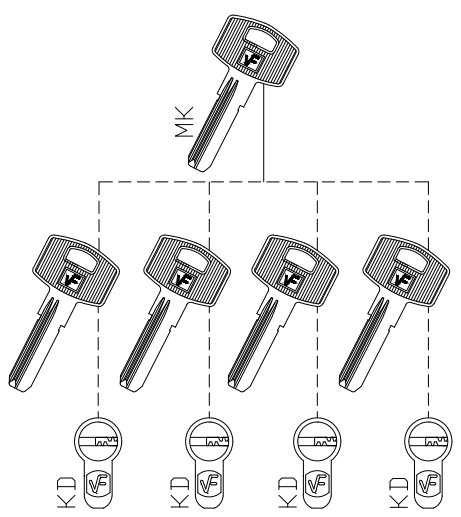

CODE <i>COD</i>	A	B mm.	L	PINS <i>Nr. Stifturi</i>	1 PCS EACH BOX <i>Buc/cutie</i>
110600_MK	30	30	60	12	1
110651_MK	30	35	65	12	1
110700_MK	35	35	70	12	1
110701_MK	30	40	70	12	1
110800_MK	40	40	80	12	1
110802_MK	35	45	80	12	1
110852_MK	40	45	85	12	1
110900_MK	45	45	90	12	1
110902_MK	40	50	90	12	1
110951_MK	40	55	95	12	1
110952_MK	45	50	95	12	1





Construction/definitive keys Cheie de constructie/definitiva

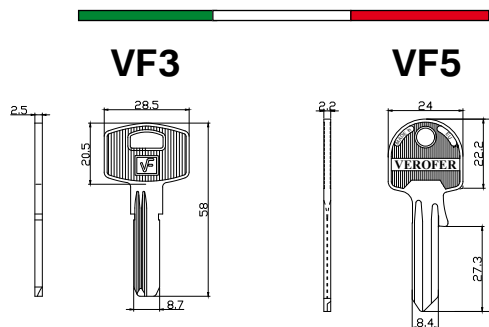
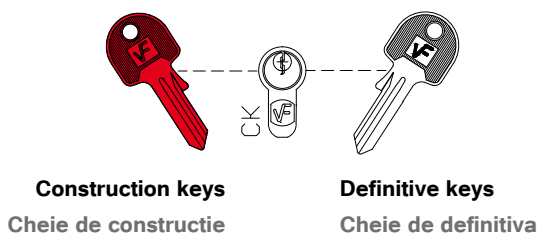

Keys
 Cheie

CODE <i>COD</i>	A	B mm.	L	PINS <i>Nr. Stifturi</i>	1 PCS EACH BOX <i>Buc/cutie</i>
110600_CC	30	30	60	10	1
110651_CC	30	35	65	10	1
110700_CC	35	35	70	10	1
110701_CC	30	40	70	10	1
110800_CC	40	40	80	10	1
110802_CC	35	45	80	10	1
110852_CC	40	45	85	10	1
110900_CC	45	45	90	10	1
110902_CC	40	50	90	10	1
110951_CC	40	55	95	10	1
110952_CC	45	50	95	10	1

Thumbturn
 Buton

CODE <i>COD</i>	A	B mm.	L	PINS <i>Nr. Stifturi</i>	1 PCS EACH BOX <i>Buc/cutie</i>
110600B_CC	30	30	60	5	1
110651BL_CC	30	35	65	5	1
110700B_CC	35	35	70	5	1
110701BL_CC	30	40	70	5	1
110800B_CC	40	40	80	5	1
110802BL_CC	35	45	80	5	1
110852BL_CC	40	45	85	5	1
110900B_CC	45	45	90	5	1
110902BL_CC	40	50	90	5	1
110951BL_CC	40	55	95	5	1
110952BL_CC	45	50	95	5	1



Emergency function Cilindru cu functia de urgenta

Cylinders are in brass supplied with:

- . brass nichel keys
- . cam UNI or DIN
- . fixing screw M 5x60

Cilindri sunt dotati cu:

- . chei din alama nichelate
- . paleta UNI sau DIN
- . surub M 5x60

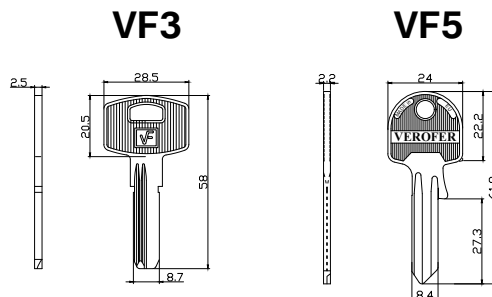
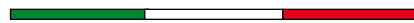
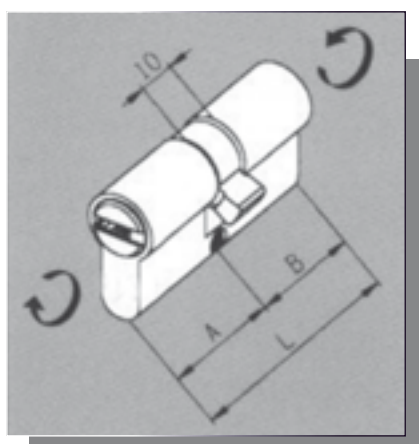

CODE <i>COD</i>	A	B mm.	L	PINS <i>Nr. Stifuri</i>	1 PCS EACH BOX <i>Buc/cutie</i>
110600_DF	30	30	60	5	1
110651_DF	30	35	65	5	1
110700_DF	35	35	70	5	1
110701_DF	30	40	70	5	1
110800_DF	40	40	80	5	1
110802_DF	35	45	80	5	1
110852_DF	40	45	85	5	1
110900_DF	45	45	90	5	1
110902_DF	40	50	90	5	1
110951_DF	40	55	95	5	1
110952_DF	45	50	95	5	1

Cylinder for thumbturn Cilindru pt buton

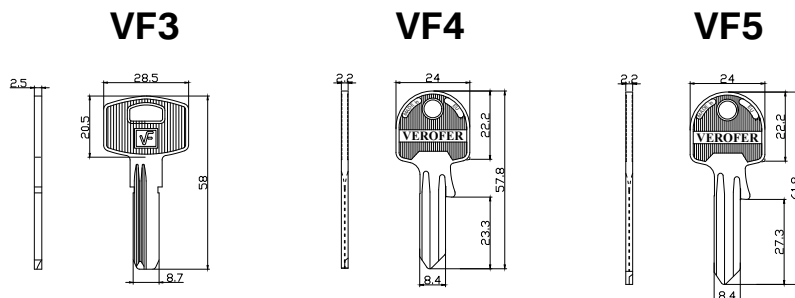
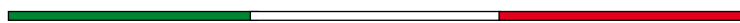
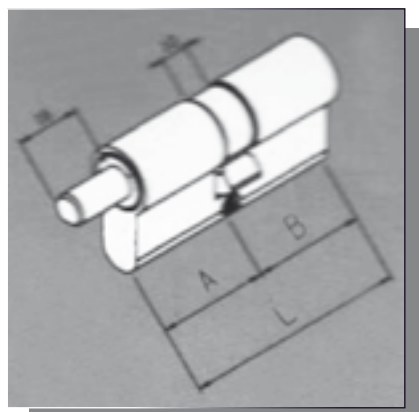

Paleta UNI

Paleta DIN

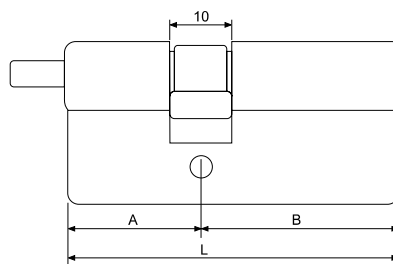
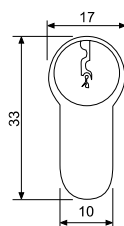
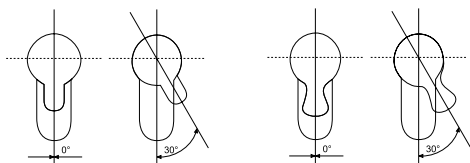



Individual keys Cheie individuala

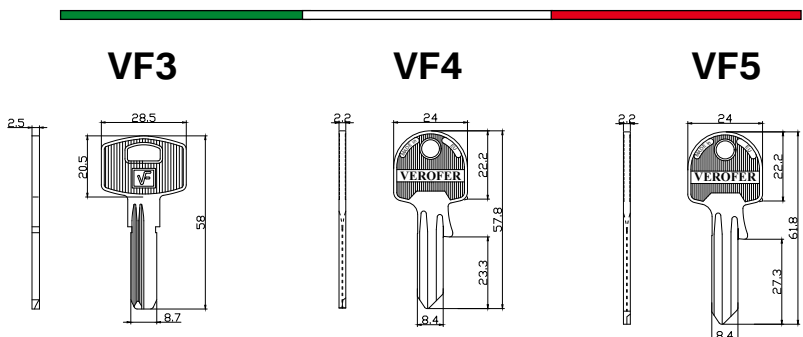
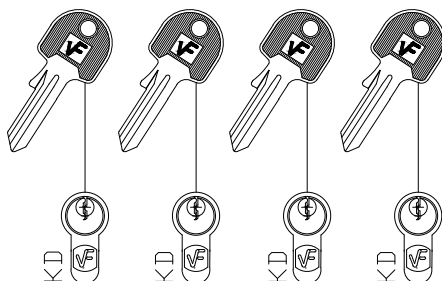

Same keys Aceeasi cheie

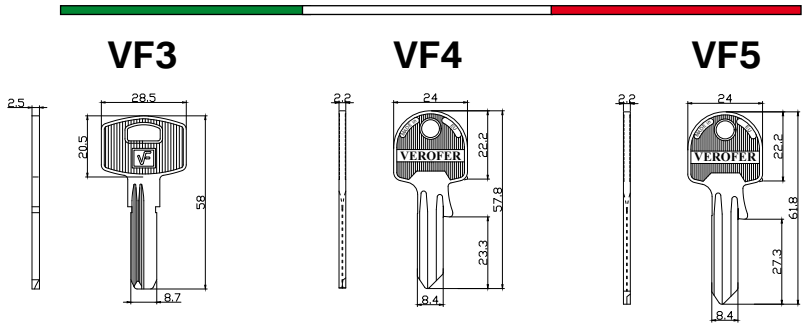
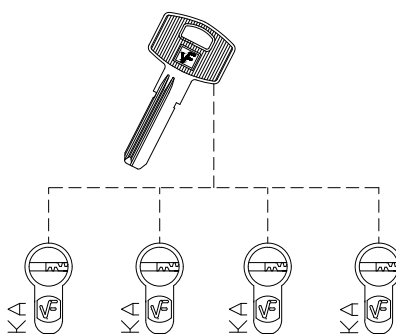





LOCKS FOR WOODEN DOORS
BROASTE PENTRU USI DIN LEMN

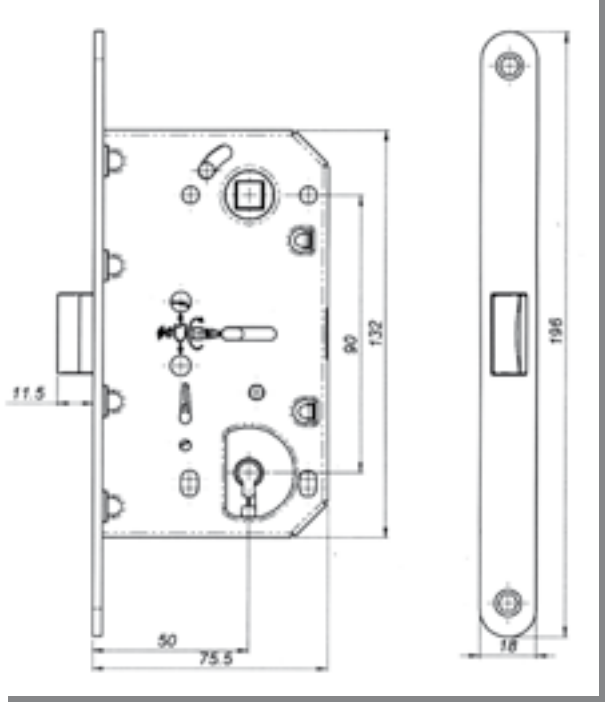

 **035-199**



Cod. produs	Tip	Characteristics	L	A	Finishing	Packing	Striking Plate
035-199	P		90	A50	ZCS	50	035-204 035-207 035-210
035-200	Y	 DIN	85				
035-201	WC	Q 6	96				

The door lock is reversible. The door latch could be retreated also by using the key.
Broasca este reversibila. Limba broastei se poate retrage si din cheie.





035-29

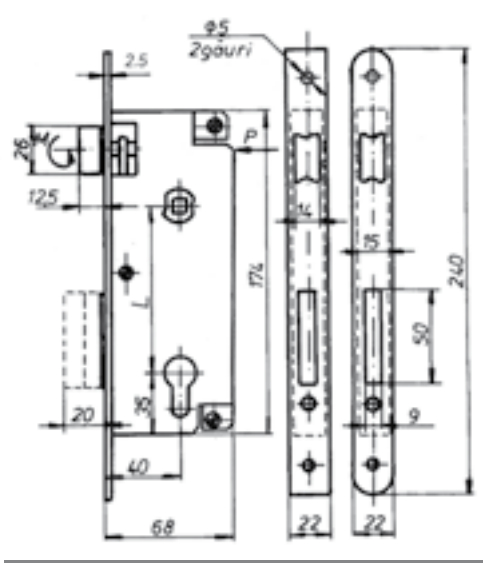

Cod. produs	Tip	Characteristics	L	A	Finishing	Packing	Striking Plate
035-32	P		90	A40	PAINTED	20/1	035-59
035-29							
035-18	Y	 UNI	85				
035-89	WC	Q.8	90				

The door lock is reversible. In case of Y type the door latch could be retreated also by using the key.
Broasca este reversibila. La varianta Y limba broastei se poate retrage si din cheie.



LOCKS FOR WOODEN DOORS
BROASTE PENTRU USI DIN LEMN



035-154

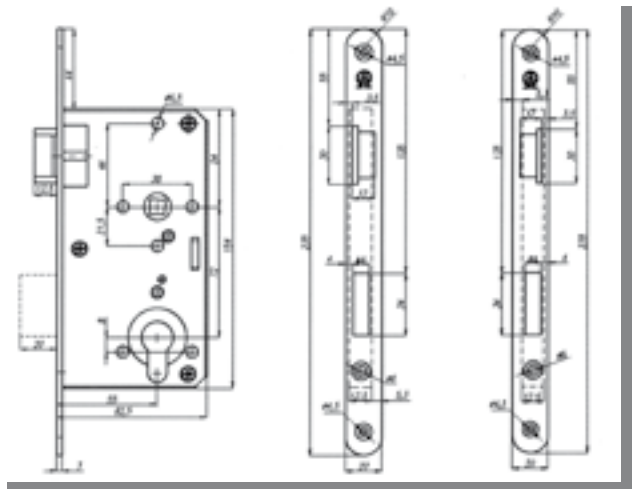

Cod. produs	Tip	Characteristics	L	A	Finishing	Packing	Striking Plate
035-154	P left	DIN	72	A55	ZI ZA S PAINTED+ NATUR	20/01	035-183
035-155	P right						
035-186	P						
035-150	Y left						
035-151	Y right						
035-187	Y						
035-152	WC left	Q.6,8	72				
035-153	WC right		78				
035-188	WC		78				

The door lock is not reversible. In case of Y type the door latch could be retreated also by using the key.
Broasca nu este reversibila. La varianta Y limba broastei se poate retrage si din cheie.





035-174

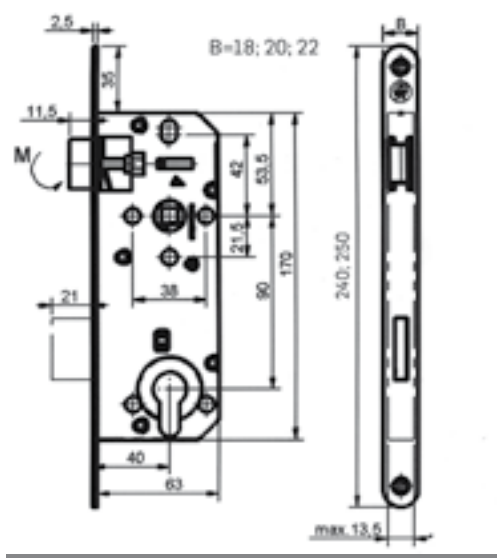

Cod. produs	Tip	Characteristics	L	A	Finishing	Packing	Striking Plate
035-174	P		90	A40	ZI		
035-181				A50			
035-175	Y		85	A40	ZA	20/01	035-178
035-182				A50			
035-177				A40			
035-180	WC	Q.6,8	90	A40	PAINTED+ NATUR		
035-184				A50			

The door lock is reversible. In case of 035-182 type the door latch could be retreated also by using the key.
Broasca este reversibila. La varianta 035-182 limba broastei se poate retrage si din cheie.



LOCKS FOR ALLUMINIUM DOORS
BROASTE PENTRU USI DIN ALUMINIU



 **035-91**

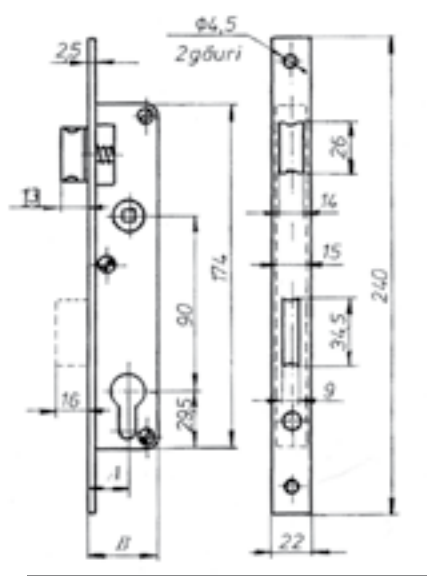

Cod. produs	Tip	Characteristics	L	A	Finishing	Packing	Striking Plate
035-92	Y		92	A35	NIK+ZA	20/1	035-122
035-91			85	A35			
035-108			92	A30			
035-106			85	A30			
035-115			92	A25			
035-113			85	A25			
		DIN					

The door lock is reversible. The door latch could be retreated also by using the key.
Broasca este reversibila. Limba broastei se poate retrage si din cheie.





035-96

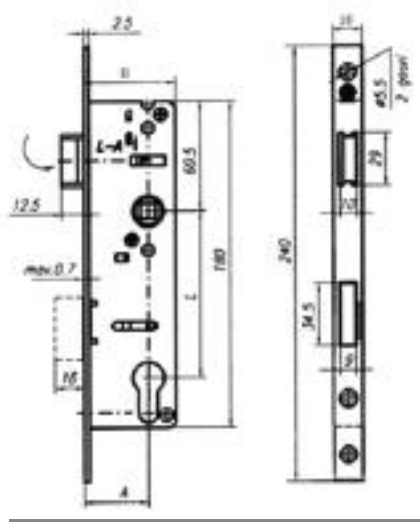

Cod. produs	Tip	Characteristics	L	A	Finishing	Packing	Striking Plate
035-96	Y	 DIN	92	A35	NIK+ZA	20/1	035-171L 035-172 R
035-95			85	A35			
035-111			92	A30			
035-109			85	A30			
035-123			92	A25			
035-118			85	A25			
035-158			85	A20			

The door lock is reversible. The door latch could be retreated also by using the key.
Broasca este reversibila. Limba broastei se poate retrage si din cheie.



STRIKING PLATES
CONTRA PLACI



035-59 - OP

Striking plates

Contra placi



50

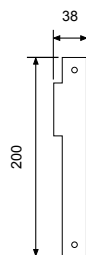

035-183 - ZA

Striking plates

Contra placi



50

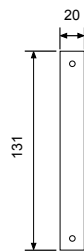

035-171L - ZA

Striking plates

Contra placi



50





035-204 - CRS

Striking plates

Contro placi



50

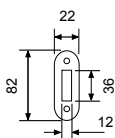

035-210 - CRS

Striking plates

Contro placi



50

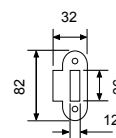

035-178 - CMR

Striking plates

Contro placi



50

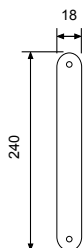

035-207 - CMR

Striking plates

Contro placi



50

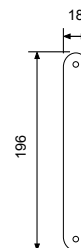



ACCESSORIES FOR SLIDING DOORS
ACCESORII PENTRU USI GLISANTE



035-200S - OL

Sliding-door wc lock
with striking plate

*Broasca baie pentru
usi glisante cu tablita*



20

A	B	C	D
50	16	70	100

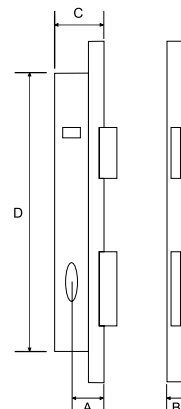

316032P - OL

Pair of inset wc-handles
with pull flush

*Set manere ovale baie pentru
usi glisante cu elem.tragere*



20

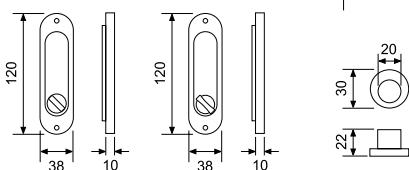

035-200SR - OL

kit of sliding-door wc lock
with inset handles and striking plate

*Set broasca baie cu tablita, manere
si element tragere pentru usi glisanteusi*



20



316032R - OL

316039R - OL

Pair of inset wc-handles
with pull flush

*Set manere rotunde baie pentru
usi glisante cu elem.tragere*



20

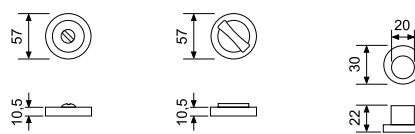



035-201S - OL

sliding-door wc lock with striking plate

broasca baie pentru usi glisante cu tablita



20

A	B	C	D
50	16	70	100

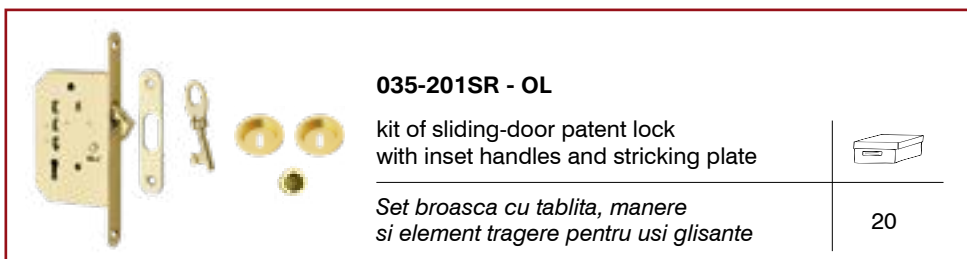
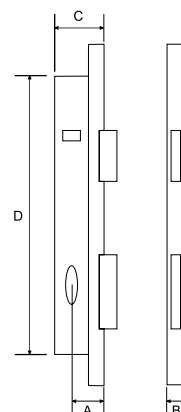

035-201SR - OL

kit of sliding-door patent lock with inset handles and striking plate

Set broasca cu tablita, manere si element tragere pentru usi glisante



20



316031P - OL

Pair of inset wc-handles with pull flush

Set manere ovale cheie pentru usi glisante cu elem.tragere



20

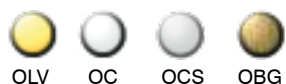
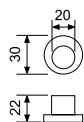
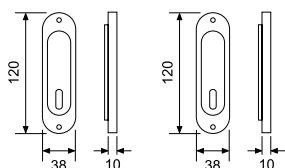

OLV OC OCS OBG



316031R - OL

Pair of inset wc-handles with pull flush

set manere rotunde cheie pentru usi glisante cu elem.tragere



20

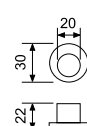
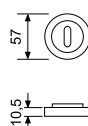
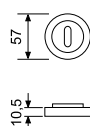



ACCESSORIES FOR SLIDING DOORS
 ACCESORII PENTRU USI GLISANTE



035-200S - CS

Sliding-door wc lock with striking plate

Broasca baie pentru usi glisante cu tablita

	20
--	----

A	B	C	D
50	16	70	100

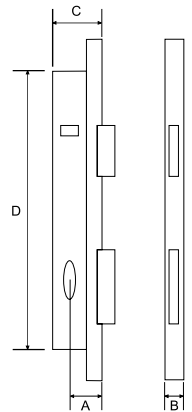



035-200SQ - CS

Kit of sliding-door wc lock with inset handles and striking plate

Set broasca baie cu tablita, manere si element tragere pentru usi glisante

	20
--	----



316032Q - CS



316039Q - CS

Pair of inset wc-handles

Set manere rotunde baie pentru usi glisante

	20
--	----

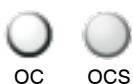
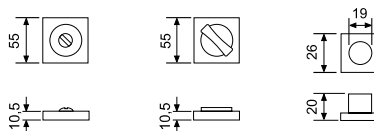



The companies Binalia - Verofer
reserve the right to change products
specifications without prior notice.
Descriptions, photos, colours and product
sizes are not binding.

Comaniile Verofer si Binalia
*isi rezerva dreptul de a actualiza
specificatiile tehnice din prezentul catalog
fara o informare in prealabil.*

GENERAL SALES RULES

ORDERS

The following sales conditions rule over all the orders accepted by SC VEROFER SRL.

TRANSPORT

The transport company assumes its responsibility for all the risks and all the threats that occurs during the transport process even if our company organises the spediton directly to our customers by using a third transport company. SC VEROFER SRL does not assume its responsibility for eventual delays caused by the transport companies.

CLAIMS

In case of eventual claims our company must be informed in maximum 10 days after the checking on delivery.

We do not accept returns of the goods that were delivered according to the original order that we received from our customer. In any case when a client want to return a quantity of goods, the list of the goods to be returned must be accepted in advance by SC VEROFER SRL.

GUARANTEE

With the present SC VEROFER SRL guarantees that all its production programe is controled against the vices of production process. This mentioned guarantee is limited to the duty of SC VEROFER SRL to replace the goods that it recognize as having deficiencies without any other responsibility.

TERMS OF DELIVERY

The eventual delays in delivery do not give to our customers the right to pretend any reparation.

PRODUCT

The information contained inside this catalogue is approximate.

SC VEROFER SRL reserves his rights to improve the characteristics of its goods relative to the continue technical evolution.

DISPUTES

Any eventual dispute concerning the delivered goods or concerning our agreement will be judged by the instance court of ARAD.

CONDITII GENERALE DE VANZARE

COMENZI

Condițiile prezentate mai jos se aplică tuturor comenzilor acceptate de către SC VEROFER SRL.

TRANSPORT

Transportatorul răspunde pentru eventualele riscuri și pericole survenite pe parcursul transportului chiar și atunci când expedierea este făcută de către firma noastră la adresa beneficiarului prin intermediul unui terț transportator.

SC VEROFER SRL nu răspunde pentru întârzierile la livrare datorate transportatorilor.

EVENTUALE RECLAMAȚII

Eventualele reclamații trebuie transmise în scris în cel mult 10 zile de la recepționarea mărfii de către beneficiar.

Nu se acceptă restituiri de marfă atunci când livrarea a fost făcută de către furnizor conform comenzii inițiale a beneficiarului. In orice situație în care se dorește efectuarea unui retur de marfă, lista cu produsele returnate trebuie acceptată în prealabil de către SC VEROFER SRL.

GARANȚII

SC VEROFER SRL garantează pe această cale că toate produsele realizate sunt verificate împotriva viciilor ce pot surveni pe parcursul procesului de producție.

Garanția anterior menționată se exercită prin înlocuirea produsului recunoscut de către noi ca fiind defect fără a atrage în astfel de cazuri acordarea unor eventuale despăgubiri.

TERMENE DE LIVRARE

SC VEROFER SRL nu acordă garanții generale de nici o natură în ceea ce privește termenele de livrare. Eventualele întârzieri nu conferă dreptul beneficiarului de a pretinde despăgubiri indiferent de natura acestora.

PRODUS

Informațiile conținute în acest catalog sunt furnizate cu titlu informativ.

SC VEROFER SRL își rezervă dreptul de a ameliora fără preaviz caracteristicile produselor sale în funcție de permanenta evoluție tehnologică.

LITIGII

Soluționarea tuturor eventualelor litigii referitoare la marfă sau la contractul de colaborare este de competența instanței judecătorești din Arad.



STYLE



TRADITION



SECURITY



HIGH FIDELTY



CONFORT



INNOVATION

 **BINALIA**®

Tel. +40 257 289 734
Fax +40 257 256 700

vanzari@binalia.ro
www.binalia.ro

Calea 6 Vanatori, 51/53
310162 Arad - Romania



MADE IN EU

G.E.A.
INVESTSRL

commerciale@geainvest.ir
Tel. +39 0365 88052

 **Verofer**®

Tel. +40 257 270 999
Fax +40 257 270 888

vanzari@verofer.ro
www.verofer.ro