

**CATALOGO | CATALOGUE 2025-26**



**FP PATTARONI**

MADE IN ITALY

**RACCORDERIA IDRAULICA  
BRASS FITTINGS**



P

FP PATTARONI

MADE IN ITALY



P

FP PATTARONI

MADE IN ITALY

## L'AZIENDA

L'Azienda si trova a San Maurizio d'Opaglio, cittadina nota soprattutto per essere il cuore del distretto industriale del rubinetto, con numerose aziende del settore.

La FP PATTARONI Srl nasce nel 2003 per creare una produzione di raccorderia in ottone di qualità e strettamente Made in Italy, che si potesse differenziare da quella presente sul mercato. Tutti gli articoli sono studiati nell'ottica di avere un prodotto non solo bello esteticamente, ma resistente nel tempo.

Questa scelta si è rivelata vincente ed ha permesso alla FP PATTARONI di far conoscere il proprio marchio sia in Italia che all'Estero.

Con la presenza alle più importanti fiere del settore, sia in Europa che nel Medio Oriente, l'Azienda è cresciuta di anno in anno.

Uno dei punti ai quali è sempre stata data particolare rilevanza è il controllo qualità: a dimostrarlo è l'ottenimento della certificazione ISO 9001:2015.

Negli ultimi anni l'Azienda ha ampliato la propria superficie di produzione, potenziando il reparto torneria ed imballaggio, inserendo magazzini robotizzati e macchine per insacchettamento automatico.

## THE COMPANY

The company is located in San Maurizio d'Opaglio, a town known for being the heart of the industrial tap district, with numerous historical companies in the sector.

FP PATTARONI Srl was founded in 2003 to create a production of brass fittings that could be different from those in the market, which peculiarities will be the high quality and strictly Made in Italy.

All articles are designed to produce a fitting that is not just aesthetically pleasing but also durable over the time.

This was a winning choice and allowed FP PATTARONI to become a brand well-known both in Italy and abroad.

Taking part in some of the most important trade fairs in the sector, both in Europe and the Middle East, the company has grown year by year.

One of the main aspect where all the production's lines are focused is the quality control.

A proof of that is the obtainment of the certificate ISO 9001:2015.

In a perspective of growth and to extend its production, the Company has invested in a new building and new machines, enhancing the turnery department and the packaging lines.

## MISSION

La FP PATTARONI, fin dall'inizio, ha puntato su un prodotto diverso da quello presente sul mercato, così da garantire qualità e resistenza nel tempo e soprattutto Made in Italy.

Since the beginning, the FP PATTARONI has been focused on a product that is different from those on the market, so as to guarantee quality and resistance over time, and above all, strictly Made in Italy.

## VISION

Vogliamo essere, nel mondo, un marchio riconosciuto per la qualità dei propri prodotti. Un'azienda innovativa, in continua evoluzione, che migliora e amplia la propria gamma di prodotti da offrire alla Clientela

We want to be, in the world, a brand known for the quality of its products. An innovative, constantly evolving Company that improves and expands its range of products for its Customers

## VALORI

I valori a cui aspiriamo sono Etica ed Eccellenza.

The values to which we aspire are: Ethics and Excellence.





Serie SMART  
SMART serie

**11**



RACCORDI  
FITTINGS

**17**



COLLETTORI E ARREDOVALVOLE  
MANIFOLDS AND  
VALVE FURNITURE

**53**



CANNE E TUBI  
CONNECTIONS AND PIPES

**73**



**CURVETTE E RUBINETTI  
ELBOWS AND TAPS**

**81**



**VALVOLE  
VALVES**

**89**



**ROSONI ED ECCENTRICI  
ROSETTES AND ECCENTRICS**

**95**



**VARIE  
VARIOUS**

**99**

F001	12	Serie Smart	F191	50	Raccordi
F002	12	Serie Smart	F192	24	Raccordi
F003	12	Serie Smart	F193	28	Raccordi
F004	13	Serie Smart	F194	26	Raccordi
F004	15	Serie Smart	F194	33	Raccordi
F005	13	Serie Smart	F195	29	Raccordi
F005	15	Serie Smart	F196	28	Raccordi
F006	13	Serie Smart	F197	27	Raccordi
F006	15	Serie Smart	F198	24	Raccordi
F007	13	Serie Smart	F199	27	Raccordi
F007	15	Serie Smart	F2	83	Curvette e rubinetti
F008	14	Serie Smart	F20	30	Raccordi
F009	14	Serie Smart	F200	49	Raccordi
F010	14	Serie Smart	F2002	79	Canne e tubi
F0119	86	Curvette e rubinetti	F201	49	Raccordi
F0147	86	Curvette e rubinetti	F202	49	Raccordi
F0266	86	Curvette e rubinetti	F203	49	Raccordi
F040	82	Curvette e rubinetti	F204	93	Valvole
F041	82	Curvette e rubinetti	F208	43	Raccordi
F043	27	Raccordi	F209	43	Raccordi
F044	83	Curvette e rubinetti	F21	47	Raccordi
F045	83	Curvette e rubinetti	F210	44	Raccordi
F050CL	102	Varie	F211	44	Raccordi
F094	84	Curvette e rubinetti	F212	44	Raccordi
F095	84	Curvette e rubinetti	F213	44	Raccordi
F1	84	Curvette e rubinetti	F2150	79	Canne e tubi
F10	100	Varie	F2151	94	Valvole
F100	38	Raccordi	F2152	92	Valvole
F100KIT	102	Varie	F216	97	Rosoni ed eccentrici
F101KIT	102	Varie	F217	97	Rosoni ed eccentrici
F104	103	Varie	F218	49	Raccordi
F107R	34	Raccordi	F22	47	Raccordi
F108	79	Canne e tubi	F236	77	Canne e tubi
F11	101	Varie	F24	96	Rosoni ed eccentrici
F126	41	Raccordi	F240	76	Canne e tubi
F129	21	Raccordi	F250	90	Valvole
F13	45	Raccordi	F251	35	Raccordi
F130	20	Raccordi	F254	90	Valvole
F130	33	Raccordi	F270	27	Raccordi
F131	20	Raccordi	F271	28	Raccordi
F132	22	Raccordi	F272	28	Raccordi
F134	37	Raccordi	F29	46	Raccordi
F138	20	Raccordi	F290	26	Raccordi
F139	21	Raccordi	F298	35	Raccordi
F14	45	Raccordi	F3	92	Valvole
F140	21	Raccordi	F30	46	Raccordi
F142	85	Curvette e rubinetti	F300	35	Raccordi
F143	21	Raccordi	F3001	61	Collettori e arredoalvole
F149	12	Serie Smart	F3002	61	Collettori e arredoalvole
F152	36	Raccordi	F301	35	Raccordi
F162	23	Raccordi	F302	36	Raccordi
F163	76	Canne e tubi	F303	37	Raccordi
F164	75	Canne e tubi	F305	77	Canne e tubi
F165	23	Raccordi	F31	46	Raccordi
F166	47	Raccordi	F318	76	Canne e tubi
F168	50	Raccordi	F32	46	Raccordi
F169	43	Raccordi	F321	75	Canne e tubi
F17	44	Raccordi	F380	87	Curvette e rubinetti
F171	42	Raccordi	F382	87	Curvette e rubinetti
F178	96	Rosoni ed eccentrici	F3900	63	Collettori e arredoalvole
F179	96	Rosoni ed eccentrici	F4	91	Valvole
F18	31	Raccordi	F4000	63	Collettori e arredoalvole
F185	23	Raccordi	F401	48	Raccordi
F189	22	Raccordi	F403	48	Raccordi
F19	31	Raccordi	F404	48	Raccordi

F405	48	Raccordi	F5450	72	Collettori e arredoalvole
F4100	63	Collettori e arredoalvole	F54CR	103	Varie
F413	77	Canne e tubi	F554	51	Raccordi
F415	94	Valvole	F559	51	Raccordi
F4150	64	Collettori e arredoalvole	F5600	70	Collettori e arredoalvole
F418	93	Valvole	F57	36	Raccordi
F419	93	Valvole	F571	51	Raccordi
F425	78	Canne e tubi	F579	93	Valvole
F4250	64	Collettori e arredoalvole	F591	22	Raccordi
F426	78	Canne e tubi	F592	25	Raccordi
F427	78	Canne e tubi	F593	24	Raccordi
F428	78	Canne e tubi	F594	25	Raccordi
F4300	64	Collettori e arredoalvole	F5K	91	Valvole
F4350	65	Collettori e arredoalvole	F6	37	Raccordi
F4400	65	Collettori e arredoalvole	F6000	71	Collettori e arredoalvole
F4450	65	Collettori e arredoalvole	F602	94	Valvole
F45	94	Valvole	F604	101	Varie
F4500	66	Collettori e arredoalvole	F605	101	Varie
F4550	66	Collettori e arredoalvole	F606	101	Varie
F46	92	Valvole	F607	90	Valvole
F4600	67	Collettori e arredoalvole	F608	90	Valvole
F4650	67	Collettori e arredoalvole	F613	85	Curvette e rubinetti
F47	84	Curvette e rubinetti	F620	87	Curvette e rubinetti
F4700	67	Collettori e arredoalvole	F621	87	Curvette e rubinetti
F4750	68	Collettori e arredoalvole	F622	50	Raccordi
F4900	66	Collettori e arredoalvole	F65	92	Valvole
F5	91	Valvole	F6500	71	Collettori e arredoalvole
F500	25	Raccordi	F7	83	Curvette e rubinetti
F5000	69	Collettori e arredoalvole	F7000	71	Collettori e arredoalvole
F501	25	Raccordi	F71	82	Curvette e rubinetti
F505	30	Raccordi	F72	82	Curvette e rubinetti
F506	74	Canne e tubi	F780	85	Curvette e rubinetti
F507	74	Canne e tubi	F782	85	Curvette e rubinetti
F508	74	Canne e tubi	F796	20	Raccordi
F509	74	Canne e tubi	F8	100	Varie
F51	42	Raccordi	F80	100	Varie
F5100	69	Collettori e arredoalvole	F800	38	Raccordi
F517	54	Collettori e arredoalvole	F801	38	Raccordi
F517	59	Collettori e arredoalvole	F802	31	Raccordi
F518	54	Collettori e arredoalvole	F802	32	Raccordi
F519	54	Collettori e arredoalvole	F803	31	Raccordi
F52	42	Raccordi	F803	32	Raccordi
F520	54	Collettori e arredoalvole	F804	30	Raccordi
F5200	69	Collettori e arredoalvole	F805	23	Raccordi
F521	55	Collettori e arredoalvole	F807	104	Varie
F522	55	Collettori e arredoalvole	F808	104	Varie
F523	55	Collettori e arredoalvole	F809	104	Varie
F524	55	Collettori e arredoalvole	F88	18	Raccordi
F525	55	Collettori e arredoalvole	F89	19	Raccordi
F527	56	Collettori e arredoalvole	F9	100	Varie
F528	56	Collettori e arredoalvole	F90	18	Raccordi
F529	56	Collettori e arredoalvole	F90 COLOR	35	Raccordi
F53	36	Raccordi	F91	18	Raccordi
F530	56	Collettori e arredoalvole	F92	18	Raccordi
F5300	69	Collettori e arredoalvole	F92 COLOR	35	Raccordi
F531	57	Collettori e arredoalvole	F93	23	Raccordi
F532	57	Collettori e arredoalvole	F94	19	Raccordi
F533	57	Collettori e arredoalvole	F95	19	Raccordi
F534	57	Collettori e arredoalvole	F97	103	Varie
F535	58	Collettori e arredoalvole	F98	103	Varie
F536	58	Collettori e arredoalvole	F986	75	Canne e tubi
F537	58	Collettori e arredoalvole	F99	19	Raccordi
F5400	72	Collettori e arredoalvole	ISL001	97	Rosoni ed eccentrici
F541	51	Raccordi			
F543	59	Collettori e arredoalvole			







# FP PATTARONI

MADE IN ITALY

## Serie SMART SMART serie



**F001**Nipples MM  
*Nipples MM*

GIALLO   YELLOW			
CODICE CODE	MISURA SIZE		
F001R001	3/8"	10	300
F001R002	1/2"	10	200
F001R003	3/4"	10	100
F001R004	1"	10	50
F001R005	1"1/4	5	50
F001R006	1"1/2	5	20
F001R007	2"	5	15



CROMATO   CHROME			
CODICE CODE	MISURA SIZE		
F001CR001	3/8"	10	300
F001CR002	1/2"	10	200
F001CR003	3/4"	10	100
F001CR004	1"	10	50

**F002**Nipples ridotto MM  
*Reduced nipples MM*

GIALLO   YELLOW			
CODICE CODE	MISURA SIZE		
F002R002	1/2"x3/8"	10	200
F002R003	3/4"x1/2"	10	120
F002R004	1"x3/4"	10	60
F002R005	1"x1/2"	10	70
F002R006	1"1/4x1"	5	20
F002R007	1"1/4x1"1/2	5	15



CROMATO   CHROME			
CODICE CODE	MISURA SIZE		
F002CR002	1/2"x3/8"	10	200
F002CR003	3/4"x1/2"	10	120
F002CR004	1"x3/4"	10	60
F002CR005	1"x1/2"	10	70



**F003**Riduzione esagonale MF  
*Hexagonal reduction MF*

GIALLO   YELLOW			
CODICE CODE	MISURA SIZE		
F003R002	1/2"Mx3/8"F	25	300
F003R003	3/4"Mx1/2"F	10	200
F003R004	1"Mx3/4"F	10	100
F003R005	1"Mx1/2"F	10	100
F003R006	1"1/4Mx1"F	5	50
F003R007	1"1/2Mx1"1/4F	5	30

CROMATO   CHROME			
CODICE CODE	MISURA SIZE		
F003CR002	1/2"Mx3/8"F	25	300
F003CR003	3/4"Mx1/2"F	10	200
F003CR004	1"Mx3/4"F	10	100
F003CR005	1"Mx1/2"F	10	100

**F149**Prolunga con esagono interno  
*Extension with internal hexagon*



GIALLO   YELLOW			
CODICE CODE	MISURA SIZE		
F149R008	1/2"x10	10	200
F149R009	1/2"x15	10	150
F149R010	1/2"x20	10	120
F149R011	1/2"x25	10	100
F149R012	1/2"x30	10	100
F149R013	1/2"x40	10	80
F149R014	1/2"x50	10	60

CROMATO LUCIDO   CHROME-PLATED			
CODICE CODE	MISURA SIZE		
F149CR008	1/2"x10	10	200
F149CR009	1/2"x15	10	150
F149CR010	1/2"x20	10	120
F149CR011	1/2"x25	10	100
F149CR012	1/2"x30	10	100
F149CR013	1/2"x40	10	80
F149CR014	1/2"x50	10	60

### F004

Gomito MF  
Elbow MF





GIALLO   YELLOW			
CODICE CODE	MISURA SIZE		
F004R001	3/8"	10	150
F004R002	1/2"	10	100
F004R003	3/4"	10	90
F004R004	1"	5	50
F004R005	1" 1/4	5	30
F004R006	1" 1/2	5	20
F004R007	2"	5	10

CROMATO LUCIDO   CHROME-PLATED			
CODICE CODE	MISURA SIZE		
F004CR001	3/8"	10	150
F004CR002	1/2"	10	100
F004CR003	3/4"	10	90
F004CR004	1"	5	50

### F005

Tee FFF  
Tee FFF





GIALLO   YELLOW			
CODICE CODE	MISURA SIZE		
F005R001	3/8"	10	100
F005R002	1/2"	10	80
F005R003	3/4"	10	60
F005R004	1"	5	40
F005R005	1" 1/4	5	20
F005R006	1" 1/2	5	18
F005R007	2"	5	12

CROMATO LUCIDO   CHROME-PLATED			
CODICE CODE	MISURA SIZE		
F005CR001	3/8"	10	100
F005CR002	1/2"	10	80
F005CR003	3/4"	10	60
F005CR004	1"	5	40

### F006

Gomito FF  
Elbow FF



GIALLO   YELLOW			
CODICE CODE	MISURA SIZE		
F006R001	3/8"	10	100
F006R002	1/2"	10	80
F006R003	3/4"	10	60
F006R004	1"	5	50
F006R005	1" 1/4	5	30
F006R006	1" 1/2	5	20
F006R007	2"	5	12

CROMATO LUCIDO   CHROME-PLATED			
CODICE CODE	MISURA SIZE		
F006CR001	3/8"	10	100
F006CR002	1/2"	10	80
F006CR003	3/4"	10	60
F006CR004	1"	5	50

### F007

Manicotto FF  
Socket FF





GIALLO   YELLOW			
CODICE CODE	MISURA SIZE		
F007R002	1/2"	10	150
F007R003	3/4"	10	120
F007R004	1"	10	100
F007R005	1" 1/4	5	80
F007R006	1" 1/2	5	60
F007R007	2"	5	15



CROMATO LUCIDO   CHROME-PLATED			
CODICE CODE	MISURA SIZE		
F007CR002	1/2"	10	150
F007CR003	3/4"	10	120
F007CR004	1"	10	100

**F008**Tappo M  
Plug M

## GIALLO | YELLOW



CODICE CODE	MISURA SIZE		
<b>F008R002</b>	1/2"	10	300
<b>F008R003</b>	3/4"	10	200
<b>F008R004</b>	1"	10	100

## CROMATO | CHROME



CODICE CODE	MISURA SIZE		
<b>F008CR002</b>	1/2"	10	300
<b>F008CR003</b>	3/4"	10	200
<b>F008CR004</b>	1"	10	100

**F009**Tappo F  
Plug F

## GIALLO | YELLOW

CODICE CODE	MISURA SIZE		
<b>F009R002</b>	1/2"	10	350
<b>F009R003</b>	3/4"	10	200
<b>F009R004</b>	1"	10	100

## CROMATO | CHROME

CODICE CODE	MISURA SIZE		
<b>F009CR002</b>	1/2"	10	350
<b>F009CR003</b>	3/4"	10	200
<b>F009CR004</b>	1"	10	100

**F010**Tappo M con quadro  
Square plug M

## GIALLO | YELLOW

CODICE CODE	MISURA SIZE		
<b>F010R002</b>	1/2"	10	300

**PLASTICA  
PLASTIC**

Anche FP Pattaroni srl utilizza sacchetti di plastica 100% riciclabile, per garantire la salvaguardia dell'ambiente.

*FP Pattaroni srl also use 100% plastic bags recyclable, to guarantee safeguarding the environment.*

**SAPEVATE CHE...  
DO YOU KNOW...**

I nostri articoli sono realizzati su nostri disegni tecnici, studiati per garantire qualità e resistenza.

*Our products is made on our technical drawings, studied to guarantee quality and resistance.*





**F004**

Gomito MF  
Elbow MF



NICHELATO SABBBIATO | SANDBLASTED-NICKEL PLATED



CODICE CODE	MISURA SIZE		
F004NR001	3/8"	10	150
F004NR002	1/2"	10	100
F004NR003	3/4"	10	90
F004NR004	1"	5	50

**F005**

Tee FFF  
Tee FFF



NICHELATO SABBBIATO | SANDBLASTED-NICKEL PLATED



CODICE CODE	MISURA SIZE		
F005NR001	3/8"	10	100
F005NR002	1/2"	10	80
F005NR003	3/4"	10	60
F005NR004	1"	5	40

**F006**

Gomito FF  
Elbow FF



NICHELATO SABBBIATO | SANDBLASTED-NICKEL PLATED



CODICE CODE	MISURA SIZE		
F006NR001	3/8"	10	100
F006NR002	1/2"	10	80
F006NR003	3/4"	10	60
F006NR004	1"	5	50

**F007**

Manicotto FF  
Socket FF



NICHELATO SABBBIATO | SANDBLASTED-NICKEL PLATED

CODICE CODE	MISURA SIZE		
F007NR002	1/2"	10	150
F007NR003	3/4"	10	120
F007NR004	1"	10	100





FP PATTARONI

MADE IN ITALY



**RACCORDI  
FITTINGS**

RACCORDI  
FITTINGS



**F90**Gomito 90° FF  
Elbow 90° FF

## GIALLO | YELLOW



CODICE CODE	MISURA SIZE		
F90R000	1/4"	25	300
F90R001	3/8"	25	250
F90R002	1/2"	10	150
F90R003	3/4"	10	100
F90R004	1"	5	50
F90R005	1"1/4	5	25
F90R006	1"1/2	5	20
F90R007	2"	5	10
F90R008	2"1/2	1	-
F90R009	3"	1	-
F90R010	4"	1	-

## CROMATO LUCIDO | CHROME-PLATED

CODICE CODE	MISURA SIZE		
F90CR000	1/4"	25	300
F90CR001	3/8"	25	250
F90CR002	1/2"	10	150
F90CR003	3/4"	10	100
F90CR004	1"	5	50



**F91**Gomito ridotto 90° FF  
Reduced elbow 90° FF

## GIALLO | YELLOW

CODICE CODE	MISURA SIZE		
F91R000	3/4"x3/8"	10	60
F91R001	3/4"x1/2"	10	60
F91R002	1"x1/2"	5	40
F91R003	1"x3/4"	5	40

**F92**Gomito 90° MF  
Elbow 90° MF

## GIALLO | YELLOW

CODICE CODE	MISURA SIZE		
F92R000	1/4"	25	200
F92R001	3/8"	25	150
F92R002	1/2"	10	100
F92R003	3/4"	10	80
F92R004	1"	5	40
F92R005	1"1/4	5	20
F92R006	1"1/2	5	15
F92R007	2"	5	10
F92R008	2"1/2	1	-
F92R009	3"	1	-
F92R010	4"	1	-

## CROMATO LUCIDO | CHROME-PLATED

CODICE CODE	MISURA SIZE		
F92CR000	1/4"	10	200
F92CR001	3/8"	10	150
F92CR002	1/2"	10	100
F92CR003	3/4"	10	80
F92CR004	1"	5	40

**F88**Gomito 90° MF con bordino  
Elbow 90° MF with border

## GIALLO | YELLOW

CODICE CODE	MISURA SIZE		
F88R002	1/2"	10	200



## CROMATO LUCIDO | CHROME-PLATED



CODICE CODE	MISURA SIZE		
F88CR002	1/2"	10	200

**F89**

Curva 45° MF  
Elbow 45° MF



GIALLO   YELLOW			
CODICE CODE	MISURA SIZE		
F89R002	1/2"	10	120
F89R003	3/4"	10	80
F89R004	1"	10	50
F89R005	1"1/4	5	30
F89R006	1"1/2	5	15
F89R007	2"	5	8



CROMATO SABBBIATO   SANDBLASTED CHROME			
CODICE CODE	MISURA SIZE		
F89CR002	1/2"	10	120

**F99**

Curva 45° FF  
Elbow 45° FF





GIALLO   YELLOW			
CODICE CODE	MISURA SIZE		
F99R002	1/2"	10	120
F99R003	3/4"	10	80
F99R004	1"	10	50
F99R005	1"1/4	5	30
F99R006	1"1/2	5	15
F99R007	2"	5	8



CROMATO SABBBIATO   SANDBLASTED CHROME			
CODICE CODE	MISURA SIZE		
F99CR002	1/2"	10	120

**F94**

Gomito flangiato FF  
Flanged elbow FF





GIALLO   YELLOW			
CODICE CODE	MISURA SIZE		
F94R001	1/2"	10	100



CROMATO LUCIDO   CHROME-PLATED			
CODICE CODE	MISURA SIZE		
F94CR001	1/2"	10	100

**F95**

Gomito flangiato MF  
Flanged elbow MF





GIALLO   YELLOW			
CODICE CODE	MISURA SIZE		
F95R001	1/2"	10	80

CROMATO LUCIDO   CHROME-PLATED			
CODICE CODE	MISURA SIZE		
F95CR001	1/2"	10	80

**F796**Gomito 90° MM  
Elbow 90° MM

## GIALLO | YELLOW



CODICE CODE	MISURA SIZE		
F796R002	1/2"	10	150
F796R003	3/4"	10	100
F796R004	1"	5	80

## CROMATO SABBIAITO | SANDBLASTED CHROME

CODICE CODE	MISURA SIZE		
F796CR002	1/2"	10	150

**F130**TEE FFF  
TEE FFF

## GIALLO | YELLOW

CODICE CODE	MISURA SIZE		
F130R000	1/4"	25	150
F130R001	3/8"	25	130
F130R002	1/2"	10	100
F130R003	3/4"	10	60
F130R004	1"	5	50
F130R005	1 1/4"	5	30
F130R006	1 1/2"	5	25
F130R007	2"	5	12
F130R008	2 1/2"	1	5
F130R009	3"	1	3
F130R010	4"	1	-

## CROMATO LUCIDO | CHROME-PLATED

CODICE CODE	MISURA SIZE		
F130CR000	1/4"	25	150
F130CR001	3/8"	25	130
F130CR002	1/2"	10	100
F130CR003	3/4"	10	60
F130CR004	1"	5	50



**F131**TEE ridotto FFF  
Reduced TEE FFF

## GIALLO | YELLOW



CODICE CODE	MISURA SIZE		
F131R001	3/4"x1/2"x3/4"	10	60
F131R002	1"x1/2"x1"	5	50
F131R003	1"x3/4"x1"	5	50
F131R004	1 1/4"x1 1/4"x1 1/4"	5	20
F131R009	1 1/2"x1 1/2"x1 1/2"	5	15
F131R005	1 1/2"x1 1/4"x1 1/2"	5	15

**F138**TEE MFF  
TEE MFF

## GIALLO | YELLOW

CODICE CODE	MISURA SIZE		
F138R002	1/2"Mx1/2"Fx1/2"F	10	100
F138R003	3/4"Mx3/4"Fx3/4"F	5	60
F138R004	1"Mx1"Fx1"F	5	30



## CROMATO SABBIAITO | SANDBLASTED CHROME

CODICE CODE	MISURA SIZE		
F138CR002	1/2"Mx1/2"Fx1/2"F	10	100





**F139**  
TEE FMF  
TEE FMF





GIALLO   YELLOW			
CODICE CODE	MISURA SIZE		
F139R001	1/2"Fx1/2"Mx1/2"F	10	80
F139R002	3/4"Fx3/4"Mx3/4"F	5	50
F139R003	1"Fx1"Mx1"F	5	25

**F140**  
TEE MFM  
TEE MFM





GIALLO   YELLOW			
CODICE CODE	MISURA SIZE		
F140R001	1/2"Mx1/2"Fx1/2"M	10	100
F140R002	3/4"Mx3/4"Fx3/4"M	5	70

CROMATO SABBIAATO | SANDBLASTED CHROME

CODICE CODE	MISURA SIZE		
F140CR001	1/2"Mx1/2"Fx1/2"M	10	100

**F143**  
TEE MMF  
TEE MMF



GIALLO   YELLOW			
CODICE CODE	MISURA SIZE		
F143R001	1/2"Mx1/2"Mx1/2"F	10	100
F143R002	3/4"Mx3/4"Mx3/4"F	5	70

**F129**  
TEE MMM  
TEE MMM







GIALLO   YELLOW			
CODICE CODE	MISURA SIZE		
F129R003	1/2"Mx1/2"Mx1/2"M	10	100
F129R004	3/4"Mx3/4"Mx3/4"M	5	70

**F132**

Crociera a quattro vie F  
Four ways cross F





GIALLO   YELLOW			
CODICE CODE	MISURA SIZE		
F132R001	1/2"	10	60
F132R002	3/4"	5	40
F132R003	1"	5	25
F132R004	1"1/4"	5	20
F132R005	1"1/2"	5	20
F132R006	2"	5	10



CROMATO SABBIAITO   SANDBLASTED CHROME			
CODICE CODE	MISURA SIZE		
F132CR002	1/2"	10	60
F132CR003	3/4"	5	40

**F189**

Nipples MM  
Nipple MM





GIALLO   YELLOW			
CODICE CODE	MISURA SIZE		
F189R000	1/4"	25	300
F189R001	3/8"	25	250
F189R002	1/2"	10	200
F189R003	3/4"	10	140
F189R004	1"	10	80
F189R005	1"1/4"	5	50
F189R006	1"1/2"	5	40
F189R007	2"	5	20
F189R008	2"1/2"	5	10
F189R009	3"	5	-
F189R010	4"	1	-



CROMATO   CHROME			
CODICE CODE	MISURA SIZE		
F189CR000	1/4"	25	300
F189CR001	3/8"	25	250
F189CR002	1/2"	10	200
F189CR003	3/4"	10	140
F189CR004	1"	10	80
F189CR005	1"1/4"	5	50
F189CR006	1"1/2"	5	40

**F591**

Nipples ridotto MM  
Reduced nipples MM





GIALLO   YELLOW			
CODICE CODE	MISURA SIZE		
F591R000	1/8"x1/4"	25	600
F591R001	1/4"x3/8"	25	400
F591R002	1/4"x1/2"	25	350
F591R003	3/8"x1/2"	10	240
F591R004	3/8"x3/4"	10	200
F591R005	1/2"x3/4"	10	160
F591R006	1/2"x1"	10	100
F591R007	1/2"x1"1/4"	5	50
F591R008	3/4"x1"	10	60
F591R009	3/4"x1"1/4"	5	50
F591R010	1"x1"1/4"	5	40
F591R011	1"x1"1/2"	5	30
F591R012	1"x2"	5	25
F591R013	1"1/4x1"1/2"	5	20
F591R014	1"1/4x2"	5	20
F591R017	1"1/2x3/4"	5	50
F591R015	1"1/2x2"	5	25
F591R016	2"x2"1/2"	5	15
F591R021	2"x3"	5	10
F591R022	3"x2"1/2"	5	8

CROMATO   CHROME			
CODICE CODE	MISURA SIZE		
F591CR000	1/8"x1/4"	25	600
F591CR001	1/4"x3/8"	25	400
F591CR002	1/4"x1/2"	25	350
F591CR003	3/8"x1/2"	10	240
F591CR004	3/8"x3/4"	10	200
F591CR005	1/2"x3/4"	10	160
F591CR006	1/2"x1"	10	100
F591CR007	1/2"x1"1/4"	5	50
F591CR008	3/4"x1"	10	60
F591CR009	3/4"x1"1/4"	5	50
F591CR010	1"x1"1/4"	5	40
F591CR011	1"x1"1/2"	5	30
F591CR012	1"x2"	5	25
F591CR013	1"1/4x1"1/2"	5	20
F591CR014	1"1/4x2"	5	20
F591CR017	1"1/2x3/4"	5	50
F591CR015	1"1/2x2"	5	25
F591CR016	2"x2"1/2"	5	15

### F162

Raccordo curvo MF per gas  
*MF elbow for gas*





GIALLO   YELLOW				
CODICE CODE	MISURA SIZE			
F162R000	1/2" F X 1/2" M	10	200	

### F93

Gomito 3 vie FFF  
*Three ways elbow FFF*







GIALLO   YELLOW				
CODICE CODE	MISURA SIZE			
F93R001	1/2" X 1/2" X 1/2"	10	80	
F93R002	3/4" X 3/4" X 3/4"	10	50	

### F185

Nipples prolungato MM  
*Left/Right extended nipples*





GIALLO   YELLOW				
CODICE CODE	MISURA SIZE			
F185R002	1/2" X H37	10	150	

CROMATO   CHROME				
CODICE CODE	MISURA SIZE			
F185CR002	1/2" X H37	10	150	

### F165

Nipples destro e sinistro per gas  
*Left/Right nipples for gas*





GIALLO   YELLOW				
CODICE CODE	MISURA SIZE			
F165R001	1/2" SX e DX	10	150	

### F805

Raccordo diritto per pannelli solari  
*Straight fitting for solar panels*





GIALLO   YELLOW				
CODICE CODE	MISURA SIZE			
F805R003	3/4"	10	100	
F805R004	1"	10	100	

**F198**

Controdado con flangia  
Locknut with flange





GIALLO   YELLOW			
CODICE CODE	MISURA SIZE		
F198R001	3/8"	25	400
F198R002	1/2"	10	300
F198R003	3/4"	10	200
F198R004	1"	10	150
F198R005	1"1/4	10	100
F198R006	1"1/2	10	80
F198R007	2"	5	50

**F192**

Controdado senza flangia  
Locknut without flange







GIALLO   YELLOW			
CODICE CODE	MISURA SIZE		
F192R001	3/8" X H 4,5	25	800
F192R008	1/2" X H 4,0	25	750
F192R002	1/2" X H 6,0	25	700
F192R003	3/4" X H 5,0	10	350
F192R004	1" X H 6,0	10	300

**F593**

Riduzione esagonale FM  
Hexagonal reduction FM



GIALLO   YELLOW			
CODICE CODE	MISURA SIZE		
F593R000	1/4" Mx 1/8" F	25	600
F593R099	1/2" Mx 1/8" F	25	500
F593R001	3/8" Mx 1/8" F	25	550
F593R002	3/8" Mx 1/4" F	25	550
F593R003	1/2" Mx 1/4" F	10	500
F593R004	1/2" Mx 3/8" F	10	400
F593R005	3/4" Mx 3/8" F	10	300
F593R006	1" Mx 3/8" F	10	260
F593R007	3/4" Mx 1/2" F	10	240
F593R008	1" Mx 1/2" F	10	120
F593R009	1"1/4 Mx 1/2" F	5	100
F593R010	1"1/2 Mx 1/2" F	5	80
F593R012	1" Mx 3/4" F	5	100
F593R013	1"1/4 Mx 3/4" F	5	80
F593R014	1"1/2 Mx 3/4" F	5	60
F593R015	2" Mx 3/4" F	5	50
F593R016	1"1/4 Mx 1" F	5	80
F593R017	1"1/2 Mx 1" F	5	90
F593R018	2" Mx 1" F	5	30
F593R019	1"1/2 Mx 1"1/4 F	5	60
F593R020	2" Mx 1"1/4 F	5	40
F593R021	2" Mx 1"1/2 F	5	30

CROMATO   CHROME			
CODICE CODE	MISURA SIZE		
F593CR000	1/4" Mx 1/8" F	25	600
F593CR001	3/8" Mx 1/8" F	25	500
F593CR002	3/8" Mx 1/4" F	25	550
F593CR003	1/2" Mx 1/4" F	10	550
F593CR004	1/2" Mx 3/8" F	10	500
F593CR005	3/4" Mx 3/8" F	10	400
F593CR006	1" Mx 3/8" F	10	300
F593CR007	3/4" Mx 1/2" F	10	260
F593CR008	1" Mx 1/2" F	10	240
F593CR009	1"1/4 Mx 1/2" F	5	120
F593CR010	1"1/2 Mx 1/2" F	5	100
F593CR011	1" Mx 3/4" F	5	80
F593CR012	1"1/4 Mx 3/4" F	5	100
F593CR013	1"1/2 Mx 3/4" F	5	80
F593CR014	1"1/4 Mx 1" F	5	60
F593CR015	1"1/2 Mx 1" F	5	50
F593CR016	1"1/4 Fx 1"1/2" M	5	80

### F500

Ghiera di riduzione  
Reduction ring



GIALLO   YELLOW			
CODICE CODE	MISURA SIZE		
F500R002	3/8"Fx1/2"M	10	600
F500R003	1/2"Fx3/4"M	10	400
F500R004	3/4"Fx1"M	10	200
F500R005	1"Fx1"1/4M	10	120
F500R006	1"1/4Fx1"1/2M	10	90

CROMATO   CHROME			
CODICE CODE	MISURA SIZE		
F500CR002	3/8"Fx1/2"M	10	600
F500CR003	1/2"Fx3/4"M	10	400
F500CR004	3/4"Fx1"M	10	200

### F501

Ghiera di riduzione con battuta  
Reduction ring with beating



GIALLO   YELLOW			
CODICE CODE	MISURA SIZE		
F501R001	3/8"Fx1/2"M	10	600
F501R002	1/2"Fx3/4"M	10	400
F501R003	3/4"Fx1"M	10	200
F501R004	1"Fx1"1/4M	10	120
F501R005	1"1/4Fx1"1/2M	10	90

CROMATO   CHROME			
CODICE CODE	MISURA SIZE		
F501CR002	3/8"Fx1/2"M	10	600
F501CR003	1/2"Fx3/4"M	10	400
F501CR004	3/4"Fx1"M	10	200

### F592

Tappo M  
Male plug



GIALLO   YELLOW			
CODICE CODE	MISURA SIZE		
F592R001	1/4"	25	700
F592R002	3/8"	10	600
F592R003	1/2"	10	500
F592R004	3/4"	10	250
F592R005	1"	10	140
F592R006	1"1/4	5	80
F592R007	1"1/2	5	60
F592R008	2"	5	25
F592R009	2"1/2	1	15

CROMATO   CHROME			
CODICE CODE	MISURA SIZE		
F592CR001	1/4"	25	700
F592CR002	3/8"	10	600
F592CR003	1/2"	10	500
F592CR004	3/4"	10	250
F592CR005	1"	10	140
F592CR006	1"1/4	5	80
F592CR007	1"1/2	5	60
F592CR008	2"	5	25

### F594

Tappo F  
Female plug





GIALLO   YELLOW			
CODICE CODE	MISURA SIZE		
F594R000	1/4"	25	700
F594R001	3/8"	10	600
F594R002	1/2"	10	500
F594R003	3/4"	10	250
F594R004	1"	10	160
F594R005	1"1/4	5	100
F594R006	1"1/2	5	80
F594R007	2"	5	50
F594R008	2"1/2	1	25
F594R009	3"	1	-

CROMATO   CHROME			
CODICE CODE	MISURA SIZE		
F594CR000	1/4"	25	700
F594CR001	3/8"	10	600
F594CR002	1/2"	10	500
F594CR003	3/4"	10	250
F594CR004	1"	10	160
F594CR005	1"1/4	5	100
F594CR006	1"1/2	5	80



**F290**

Tappo M per collettori  
Male manifold plug

**GIALLO | YELLOW**

CODICE CODE	MISURA SIZE		
F290R001	1/2"	25	250
F290R002	3/4"	25	200
F290R003	1"	10	160



**CROMATO | CHROME**

CODICE CODE	MISURA SIZE		
F290CR001	1/2"	25	250
F290CR002	3/4"	25	200
F290CR003	1"	10	160



**F194**

Prolunga pesante  
Heavy extension

**GIALLO | YELLOW**

CODICE CODE	MISURA SIZE		
F194R001	3/8"x10	10	300
F194R002	3/8"x15	10	240
F194R003	3/8"x20	10	200
F194R005	3/8"x30	10	150
F194R006	3/8"x40	10	100
F194R007	3/8"x50	10	80
F194R031	3/8"x60	10	70
F194R032	3/8"x80	10	50
F194R033	3/8"x100	10	30
F194R008	1/2"x10	10	200
F194R009	1/2"x15	10	150
F194R010	1/2"x20	10	120
F194R011	1/2"x25	10	100
F194R012	1/2"x30	10	100
F194R013	1/2"x40	10	80
F194R014	1/2"x50	10	60
F194R015	1/2"x60	10	40
F194R016	1/2"x80	10	30
F194R017	1/2"x100	10	30
F194R018	3/4"x10	10	120
F194R019	3/4"x15	10	100
F194R020	3/4"x20	10	80
F194R034	3/4"x25	10	80
F194R021	3/4"x30	10	60
F194R022	3/4"x40	10	50
F194R023	3/4"x50	10	40
F194R035	3/4"x60	10	30
F194R036	3/4"x80	10	20
F194R037	3/4"x100	10	20
F194R024	1"x10	10	80
F194R025	1"x15	10	70
F194R026	1"x20	10	50
F194R027	1"x25	10	40
F194R028	1"x30	10	30
F194R029	1"x40	10	30
F194R030	1"x50	10	20
F194R046	1"x60	10	15
F194R044	1"x80	10	10
F194R045	1"x100	10	10
F194R038	1"1/4x10	10	10
F194R040	1"1/4x20	10	10
F194R042	1"1/4x30	10	10
F194R043	1"1/4x40	10	10



**CROMATO LUCIDO | CHROME-PLATED**

CODICE CODE	MISURA SIZE		
F194CR001	3/8"x10	10	300
F194CR002	3/8"x15	10	240
F194CR003	3/8"x20	10	200
F194CR005	3/8"x30	10	150
F194CR006	3/8"x40	10	100
F194CR007	3/8"x50	10	80
F194CR031	3/8"x60	10	70
F194CR032	3/8"x80	10	50
F194CR033	3/8"x100	10	30
F194CR008	1/2"x10	10	200
F194CR009	1/2"x15	10	150
F194CR010	1/2"x20	10	120
F194CR011	1/2"x25	10	100
F194CR012	1/2"x30	10	100
F194CR013	1/2"x40	10	80
F194CR014	1/2"x50	10	60
F194CR015	1/2"x60	10	40
F194CR016	1/2"x80	10	30
F194CR017	1/2"x100	10	30
F194CR018	3/4"x10	10	120
F194CR019	3/4"x15	10	100
F194CR020	3/4"x20	10	80
F194CR034	3/4"x25	10	80
F194CR021	3/4"x30	10	60
F194CR022	3/4"x40	10	50
F194CR023	3/4"x50	10	40
F194CR035	3/4"x60	10	30
F194CR036	3/4"x80	10	20
F194CR037	3/4"x100	10	20
F194CR024	1"x10	10	80
F194CR025	1"x15	10	70
F194CR026	1"x20	10	50
F194CR027	1"x25	10	40
F194CR028	1"x30	10	30
F194CR029	1"x40	10	30
F194CR030	1"x50	10	20
F194CR046	1"x60	10	15
F194CR044	1"x80	10	10
F194CR049	1"x100	10	10
F194CR038	1"1/4x10	10	10
F194CR040	1"1/4x20	10	10
F194CR042	1"1/4x30	10	10
F194CR043	1"1/4x40	10	10

### F043

Prolunga pesante ridotta MF  
Reduced extension MF



GIALLO   YELLOW			
CODICE CODE	MISURA SIZE		
F043R001	1/4" Mx3/8" F	10	350
F043R002	1/4" Mx1/2" F	10	200
F043R003	3/8" Mx1/2" F	10	200
F043R006	1/2" Mx3/4" F	10	120
F043R009	3/4" Mx1" F	10	100

CROMATO LUCIDO   CHROME-PLATED			
CODICE CODE	MISURA SIZE		
F043CR001	1/4" Mx3/8" F	10	350
F043CR002	1/4" Mx1/2" F	10	200
F043CR003	3/8" Mx1/2" F	10	200
F043CR006	1/2" Mx3/4" F	10	120
F043CR009	3/4" Mx1" F	10	100

### F199

Prolunga in ottone stampata a caldo  
Hot stamped extension





GIALLO   YELLOW			
CODICE CODE	MISURA SIZE		
F199R001	1/2" x10 mm	10	200
F199R002	1/2" x15 mm	10	150
F199R003	1/2" x20 mm	10	125
F199R004	1/2" x30 mm	10	100

CROMATO SABBBIATO   SANDBLASTED CHROME			
CODICE CODE	MISURA SIZE		
F199CR001	1/2" x10 mm	10	200
F199CR002	1/2" x15 mm	10	150
F199CR003	1/2" x20 mm	10	125
F199CR004	1/2" x30 mm	10	100

### F270

Manicotto FF  
Socket FF





GIALLO   YELLOW			
CODICE CODE	MISURA SIZE		
F270R000	1/4"	25	300
F270R001	3/8"	25	200
F270R002	1/2"	10	100
F270R003	3/4"	10	100
F270R004	1"	10	60
F270R005	1"1/4	5	50
F270R006	1"1/2	5	40
F270R007	2"	5	20
F270R008	2"1/2	1	-
F270R009	3"	1	-
F270R010	4"	1	-

CROMATO   CHROME			
CODICE CODE	MISURA SIZE		
F270CR000	1/4"	25	300
F270CR001	3/8"	25	200
F270CR002	1/2"	10	100
F270CR003	3/4"	10	100
F270CR004	1"	10	60

### F197

Vite semplice  
Tapping screw







GIALLO   YELLOW			
CODICE CODE	MISURA SIZE		
F197R000	3/8" x40	10	300
F197R008	3/8" x60	10	250
F197R009	1/2" x30	10	200
F197R001	1/2" x40	10	200
F197R010	1/2" x60	10	150
F197R002	3/4" x40	10	100
F197R003	1" x40	10	80
F197R004	1"1/4" x40	10	60

**F271**

Manicotto ridotto FF  
Reduced socket FF







GIALLO   YELLOW				CROMATO   CHROME			
CODICE CODE	MISURA SIZE			CODICE CODE	MISURA SIZE		
F271R014	1/4"x1/2"	25	300	F271CR014	1/4"x1/2"	25	300
F271R001	3/8"x1/2"	25	200	F271CR001	3/8"x1/2"	25	200
F271R004	1/2"x3/4"	10	150	F271CR004	1/2"x3/4"	10	150
F271R005	1/2"x1"	10	100	F271CR005	1/2"x1"	10	100
F271R006	3/4"x1"	10	100	F271CR006	3/4"x1"	10	100
F271R007	3/4"x1"1/4	5	60	F271CR007	3/4"x1"1/4	5	60
F271R008	1"x1"1/4	5	60	F271CR008	1"x1"1/4	5	60
F271R009	1"x1"1/2	5	40	F271CR009	1"x1"1/2	5	40
F271R010	1"1/4x1"1/2	5	30	F271CR010	1"1/4x1"1/2	5	30
F271R011	1"1/4x2"	5	15	F271CR011	1"1/4x2"	5	15
F271R012	1"1/2x2"	5	10	F271CR012	1"1/2x2"	5	10
F271R013	2"x1"	5	-	F271CR013	2"x1"	5	-

**F272**

Manicotto esagonale ridotto MF  
Hexagonal reduced socket MF





GIALLO   YELLOW				CROMATO   CHROME			
CODICE CODE	MISURA SIZE			CODICE CODE	MISURA SIZE		
F272R003	3/8"Mx1/2"F	10	240	F272CR003	3/8"Mx1/2"F	10	240
F272R005	1/2"Mx3/4"F	10	140	F272CR005	1/2"Mx3/4"F	10	140
F272R006	1/2"Mx1"F	10	100	F272CR006	1/2"Mx1"F	10	100
F272R017	1/2"Mx1"1/4F	5	80	F272CR017	1/2"Mx1"1/4F	5	80
F272R008	3/4"Mx1"F	10	80	F272CR008	3/4"Mx1"F	10	80
F272R015	3/4"Mx1"1/4F	5	60	F272CR015	3/4"Mx1"1/4F	5	60
F272R009	1"Mx1"1/4F	5	60	F272CR009	1"Mx1"1/4F	5	60
F272R010	1"Mx1"1/2F	5	50	F272CR010	1"Mx1"1/2F	5	50
F272R011	1"1/4Mx1"1/2F	5	30	F272CR011	1"1/4Mx1"1/2F	5	30
F272R012	1"1/2Mx2"F	5	15	F272CR012	1"1/2Mx2"F	5	15

**F193**

Barilotto scorrevole  
Sliding extension





GIALLO   YELLOW			
CODICE CODE	MISURA SIZE		
F193R000	1/2"x100	10	100
F193R001	1/2"x150	10	90
F193R002	1/2"x200	10	75
F193R003	3/4"x100	10	60
F193R004	3/4"x150	10	60
F193R005	3/4"x200	10	50
F193R006	1"x100	10	40
F193R007	1"x150	10	30
F193R008	1"x200	10	20
F193R009	1"1/4x100	5	30
F193R010	1"1/4x150	5	15
F193R011	1"1/4x200	5	10

**F196**

Barra filettata da mt. 1  
Threaded bar 1 mt.







GIALLO   YELLOW			
CODICE CODE	MISURA SIZE		
F196R000	3/8"	1	-
F196R001	1/2"	1	-
F196R002	3/4"	1	-
F196R003	1"	1	-

**F195**

Barilotto MM  
Extension MM



GIALLO   YELLOW			
CODICE CODE	MISURA SIZE		
F195R000	3/8"x50	10	300
F195R001	3/8"x60	10	250
F195R002	3/8"x80	10	200
F195R003	3/8"x100	10	200
F195R004	3/8"x120	10	150
F195R005	3/8"x150	10	120
F195R006	3/8"x200	10	100
F195R007	1/2"x50	10	150
F195R008	1/2"x60	10	130
F195R009	1/2"x80	10	100
F195R010	1/2"x100	10	80
F195R011	1/2"x120	10	80
F195R048	1/2"x130	10	80
F195R012	1/2"x150	10	70
F195R013	1/2"x200	10	60
F195R123	1/2"x250	10	50
F195R041	1/2"x300	10	-
F195R014	3/4"x50	10	120
F195R015	3/4"x60	10	100
F195R016	3/4"x80	10	80
F195R017	3/4"x100	10	70
F195R119	3/4"x110	10	70
F195R018	3/4"x120	10	60
F195R049	3/4"x130	10	50
F195R019	3/4"x150	10	40
F195R020	3/4"x200	10	30
F195R124	3/4"x250	10	20
F195R042	3/4"x300	10	-
F195R021	1"x50	10	70
F195R022	1"x60	10	60
F195R023	1"x80	10	50
F195R024	1"x100	10	40
F195R025	1"x120	10	40
F195R050	1"x130	10	35
F195R026	1"x150	10	30
F195R027	1"x200	10	25
F195R043	1"x300	10	-
F195R028	1"1/4x50	10	50
F195R029	1"1/4x60	10	40
F195R030	1"1/4x80	10	35
F195R031	1"1/4x100	5	30
F195R032	1"1/4x120	5	25
F195R033	1"1/4x150	5	20
F195R034	1"1/4x200	5	15
F195R044	1"1/4x300	5	-
F195R053	1"1/2x60	5	40
F195R051	1"1/2x80	5	30
F195R035	1"1/2x100	5	25
F195R052	1"1/2x120	5	20
F195R036	1"1/2x150	5	18
F195R037	1"1/2x200	5	10
F195R045	1"1/2x300	5	-
F195R206	2"x60	5	18
F195R207	2"x80	5	18
F195R038	2"x100	5	15
F195R039	2"x150	5	10
F195R040	2"x200	5	10

CROMATO LUCIDO   CHROME-PLATED			
CODICE CODE	MISURA SIZE		
F195CR008	1/2"x60	10	300
F195CR009	1/2"x80	10	250
F195CR010	1/2"x100	10	200
F195CR011	1/2"x120	10	200
F195CR012	1/2"x150	10	150
F195CR015	3/4"x60	10	120
F195CR016	3/4"x80	10	100
F195CR017	3/4"x100	10	150
F195CR018	3/4"x120	10	130
F195CR019	3/4"x150	10	100
F195CR022	1"x60	10	80
F195CR023	1"x80	10	80
F195CR024	1"x100	10	80
F195CR025	1"x120	10	70
F195CR026	1"x150	10	60

**SAPEVATE CHE...  
DO YOU KNOW...**

I nostri articoli sono disponibili anche in altre misure su richiesta.

*That our products are available in other sizes, on request.*





**F505**

Raccordo 5 vie  
5 ways fitting



## GIALLO | YELLOW



CODICE CODE	MISURA SIZE		
<b>F505R005</b>	1"-H=72	10	-
<b>F505R006</b>	1"-H=92	10	-

**F20**



Raccordo diritto 3 pezzi FF  
3 pieces straight fitting FF



## GIALLO | YELLOW

CODICE CODE	MISURA SIZE		
<b>F20R001</b>	1/2" - O-ring	10	100
<b>F20R002</b>	3/4" - O-ring	10	80
<b>F20R003</b>	1" - O-ring	5	30
<b>F20R004</b>	1"1/4 - conico	5	20
<b>F20R005</b>	1"1/2 - conico	5	15
<b>F20R006</b>	2" - conico	5	12

## CROMATO SABBIAITO | SANDBLASTED CHROME



CODICE CODE	MISURA SIZE		
<b>F20CR001</b>	1/2" - O-ring	10	-
<b>F20CR002</b>	3/4" - O-ring	10	-
<b>F20CR003</b>	1" - O-ring	5	-

**F804**

Raccordo diritto 3 pezzi FF sede  
piana tipo pesante  
Flat seat 3 pieces straight heavy  
fitting FF



## GIALLO | YELLOW

CODICE CODE	MISURA SIZE		
<b>F804R001</b>	1/2"	10	100
<b>F804R002</b>	3/4"	10	50
<b>F804R003</b>	1"	5	30
<b>F804R004</b>	1"1/4	5	20
<b>F804R005</b>	1"1/2	5	15
<b>F804R006</b>	2"	5	12

SAPEVATE CHE...  
DO YOU KNOW...

I nostri articoli sono progettati per garantire la pressione nominale PN16.

*That our products are made to guarantee the Nominal Pressure PN16.*

SAPEVATE CHE...  
DO YOU KNOW...

Gli articoli F18 e F19 sono compatibili sia per uso acqua sia uso gas.

*That our products F18 and F19 are usable for water and gas.*



### F18

Raccordo diritto 3 pezzi sede conica MF  
Conical seat 3 pieces straight fitting MF



GIALLO   YELLOW			
CODICE CODE	MISURA SIZE		
F18R001	3/8"	10	100
F18R002*	1/2"	1	75
F18R003*	3/4"	1	50
F18R004*	1"	1	50
F18R005	1"1/4	1	20
F18R006	1"1/2	1	18
F18R007	2"	1	7
F18R008	2"1/2	1	-
F18R009	3"	1	-
F18R010	4"	1	-

CROMATO SABBBIATO   SANDBLASTED CHROME			
CODICE CODE	MISURA SIZE		
F18NR001	3/8"	25	100
F18NR002*	1/2"	25	75
F18NR003*	3/4"	25	50
F18NR004*	1"	25	50
F18NR005	1"1/4	10	20
F18NR006	1"1/2	5	18
F18NR007	2"	5	7

(\* ) Sono provvisti di O-ring in HNBR di colore giallo / Complete with yellow HNBR OR



### F803

Raccordo diritto 3 pezzi sede piana MF  
Flat seat 3 pieces straight fitting MF



GIALLO   YELLOW			
CODICE CODE	MISURA SIZE		
F803R001	3/8"	10	100
F803R002	1/2"	1	75
F803R003	3/4"	1	45
F803R004	1"	1	45
F803R005	1"1/4	1	20
F803R006	1"1/2	1	16
F803R007	2"	1	7

CROMATO SABBBIATO   SANDBLASTED CHROME			
CODICE CODE	MISURA SIZE		
F803NR002	1/2"	1	75
F803NR003	3/4"	1	45
F803NR004	1"	1	45

### F19

Raccordo curvo 3 pezzi sede conica MF  
Conical seat 3 pieces bent fitting MF



GIALLO   YELLOW			
CODICE CODE	MISURA SIZE		
F19R001	3/8"	10	75
F19R002*	1/2"	1	50
F19R003*	3/4"	1	35
F19R004*	1"	1	20
F19R005	1"1/4	1	15
F19R006	1"1/2	1	10
F19R007	2"	1	6

CROMATO SABBBIATO   SANDBLASTED CHROME			
CODICE CODE	MISURA SIZE		
F19NR001	3/8"	10	75
F19NR002*	1/2"	1	50
F19NR003*	3/4"	1	35
F19NR004*	1"	1	20
F19NR005	1"1/4	1	15
F19NR006	1"1/2	1	10
F19NR007	2"	1	6

(\* ) Sono provvisti di O-ring in HNBR di colore giallo / Complete with yellow HNBR OR



### F802

Raccordo curvo 3 pezzi sede piana MF  
Flat seat 3 pieces bent fitting MF



GIALLO   YELLOW			
CODICE CODE	MISURA SIZE		
F802R001	3/8"	10	75
F802R002	1/2"	1	50
F802R003	3/4"	1	35
F802R004	1"	1	20
F802R005	1"1/4	1	15
F802R006	1"1/2	1	10
F802R007	2"	1	6



CROMATO SABBBIATO   SANDBLASTED CHROME			
CODICE CODE	MISURA SIZE		
F802NR002	1/2"	1	50
F802NR003	3/4"	1	35
F802NR004	1"	1	20

**F803**

Raccordo diritto 3 pezzi sede piana MF  
*Flat seat 3 pieces straight fitting MF*



## CROMATO LUCIDO | CHROME-POLISHED



CODICE CODE	MISURA SIZE		
<b>F803CR002</b>	1/2"	25	75
<b>F803CR003</b>	3/4"	25	50
<b>F803CR004</b>	1"	25	50

**F802**

Raccordo curvo 3 pezzi sede piana MF  
*Flat seat 3 pieces bent fitting MF*



## CROMATO LUCIDO | CHROME-POLISHED

CODICE CODE	MISURA SIZE		
<b>F802CR002</b>	1/2"	25	50
<b>F802CR003</b>	3/4"	25	35
<b>F802CR004</b>	1"	25	20

**SAPEVATE CHE...  
 DO YOU KNOW...**



Tutti i nostri articoli vengono sottoposti a controlli per garantire la qualità.

*That all our products are checked by our Quality Department to guarantee the top quality level.*



**F130**  
TEE FFF  
TEE FFF



F130					
CODICE CODE	FINITURA FINISH	MISURA SIZE			
F130BP001	Bianco perla / Pearl white	1/2"	10	-	
F130BN002	Blu notte / Midnight blue	1/2"	10	-	
F130VL003	Verde lucido / Glossy green	1/2"	10	-	
F130NL004	Nero lucido / Glossy black	1/2"	10	-	
F130VS005	Verde sky / Green sky	1/2"	10	-	
F130MR006	Rame spazzolato / Brushed copper	1/2"	10	-	
F130AS007	Antracite spazzolato / Brushed anthracite	1/2"	10	-	



**F194**

Prolunga pesante  
Heavy extension



F194					
CODICE CODE	FINITURA FINISH	MISURA SIZE			
F194BP008	Bianco perla / Pearl white	1/2"x10	5	-	
F194BN008	Blu notte / Midnight blue	1/2"x10	5	-	
F194VL008	Verde lucido / Glossy green	1/2"x10	5	-	
F194NL008	Nero lucido / Glossy black	1/2"x10	5	-	
F194VS008	Verde sky / Green sky	1/2"x10	5	-	
F194MR008	Rame spazzolato / Brushed copper	1/2"x10	5	-	
F194AS008	Antracite spazzolato / Brushed anthracite	1/2"x10	5	-	
F194BP009	Bianco perla / Pearl white	1/2"x15	5	-	
F194BN009	Blu notte / Midnight blue	1/2"x15	5	-	
F194VL009	Verde lucido / Glossy green	1/2"x15	5	-	
F194NL009	Nero lucido / Glossy black	1/2"x15	5	-	
F194VS009	Verde sky / Green sky	1/2"x15	5	-	
F194MR009	Rame spazzolato / Brushed copper	1/2"x15	5	-	
F194AS009	Antracite spazzolato / Brushed anthracite	1/2"x15	5	-	
F194BP010	Bianco perla / Pearl white	1/2"x20	5	-	
F194BN010	Blu notte / Midnight blue	1/2"x20	5	-	
F194VL010	Verde lucido / Glossy green	1/2"x20	5	-	
F194NL010	Nero lucido / Glossy black	1/2"x20	5	-	
F194VS010	Verde sky / Green sky	1/2"x20	5	-	
F194MR010	Rame spazzolato / Brushed copper	1/2"x20	5	-	
F194AS010	Antracite spazzolato / Brushed anthracite	1/2"x20	5	-	
F194BP012	Bianco perla / Pearl white	1/2"x30	5	-	
F194BN012	Blu notte / Midnight blue	1/2"x30	5	-	
F194VL012	Verde lucido / Glossy green	1/2"x30	5	-	
F194NL012	Nero lucido / Glossy black	1/2"x30	5	-	
F194VS012	Verde sky / Green sky	1/2"x30	5	-	
F194MR012	Rame spazzolato / Brushed copper	1/2"x30	5	-	
F194AS012	Antracite spazzolato / Brushed anthracite	1/2"x30	5	-	
F194BP014	Bianco perla / Pearl white	1/2"x50	5	-	
F194BN014	Blu notte / Midnight blue	1/2"x50	5	-	
F194VL014	Verde lucido / Glossy green	1/2"x50	5	-	
F194NL014	Nero lucido / Glossy black	1/2"x50	5	-	
F194VS014	Verde sky / Green sky	1/2"x50	5	-	
F194MR014	Rame spazzolato / Brushed copper	1/2"x50	5	-	
F194AS014	Antracite spazzolato / Brushed anthracite	1/2"x50	5	-	





BP BN VL NL VS MR AS

**F90**

Gomito 90° FF  
Elbow 90° FF





F90				
CODICE CODE	FINITURA FINISH	MISURA SIZE		
<b>F90BP001</b>	Bianco perla / Pearl white	1/2"	10	-
<b>F90BN002</b>	Blu notte / Midnight blue	1/2"	10	-
<b>F90VL003</b>	Verde lucido / Glossy green	1/2"	10	-
<b>F90NL004</b>	Nero lucido / Glossy black	1/2"	10	-
<b>F90VS005</b>	Verde sky / Green sky	1/2"	10	-
<b>F90MR006</b>	Rame spazzolato / Brushed copper	1/2"	10	-
<b>F90AS007</b>	Antracite spazzolato / Brushed anthracite	1/2"	10	-

**F92**

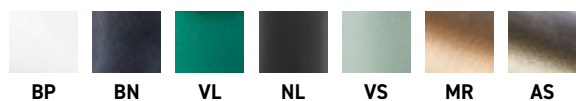
Gomito 90° MF  
Elbow 90° MF



F92				
CODICE CODE	FINITURA FINISH	MISURA SIZE		
<b>F92BP001</b>	Bianco perla / Pearl white	1/2"	10	-
<b>F92BN002</b>	Blu notte / Midnight blue	1/2"	10	-
<b>F92VL003</b>	Verde lucido / Glossy green	1/2"	10	-
<b>F92NL004</b>	Nero lucido / Glossy black	1/2"	10	-
<b>F92VS005</b>	Verde sky / Green sky	1/2"	10	-
<b>F92MR006</b>	Rame spazzolato / Brushed copper	1/2"	10	-
<b>F92AS007</b>	Antracite spazzolato / Brushed anthracite	1/2"	10	-





RACCORDI  
FITTINGS

P

FP PATTARONI

MADE IN ITALY

## RACCORDO DI RIPARAZIONE PER TUBO IN FERRO ZINCATO FITTINGS FOR FE PIPE

Raccordo di riparazione in ottone stampato per impianti con tubo in ferro.  
La tenuta meccanica è garantita da un anello conico tagliato C  
mentre la tenuta idraulica è garantita da una guarnizione tronco  
conica A unita ad una rondella B  
Pressione massima di esercizio 50 bar

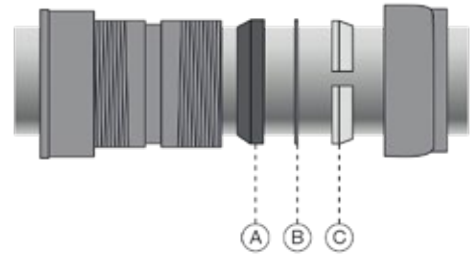



*Hot-forged brass fitting for iron pipe plants.  
The mechanical seal is guaranteed by a conical cutted ring C  
and the hydraulic-keep is guaranteed by a conical-trunk  
A gasket combined with a washer B  
Max exercise pressure bar 50*

### F800

Raccordo filetto M per tubo ferro  
zincato  
*Male fitting for galvanized iron pipe*





GIALLO   YELLOW			
CODICE CODE	MISURA SIZE		
F800R001	3/8"	1	60
F800R002	1/2"	1	50
F800R003	3/4"	1	50
F800R004	1"	1	25
F800R005	1"1/4	1	15
F800R006	1"1/2	1	10
F800R007	2"	1	-

### F801

Raccordo filetto F per tubo ferro  
zincato  
*Female fitting for galvanized iron pipe*





GIALLO   YELLOW			
CODICE CODE	MISURA SIZE		
F801R001	3/8"	1	60
F801R002	1/2"	1	50
F801R003	3/4"	1	50
F801R004	1"	1	25
F801R005	1"1/4	1	15
F801R006	1"1/2	1	10
F801R007	2"	1	-

### F107

Raccordo M per tubo polietilene  
*Male fitting for polyethylene pipe*





GIALLO   YELLOW			
CODICE CODE	MISURA SIZE		
F107R003	3/4"x25	5	40
F107R004	1"x32	5	25

**F251**

Calotta per canotto con cartella  
*Cap for brass tube with fold*





CROMATO LUCIDO   CHROME-POLISHED			
CODICE CODE	MISURA SIZE		
<b>F251CR006</b>	1"x26	10	-
<b>F251CR008</b>	1"1/4X32	10	-

**F298**

Raccordo TEE giunzione  
*TEE fitting joint*



CROMATO LUCIDO   CHROME-POLISHED			
CODICE CODE	MISURA SIZE		
<b>F298CR001</b>	10x10x10	10	150
<b>F298CR002</b>	12x12x12	10	150

**F300**

Raccordo giunzione MM  
*Joint fitting MM*



CROMATO LUCIDO   CHROME-POLISHED			
CODICE CODE	MISURA SIZE		
<b>F300CR001</b>	M3/8"x10	10	450
<b>F300CR002</b>	M3/8"x12	10	450
<b>F300CR003</b>	M1/2"x10	10	350
<b>F300CR004</b>	M1/2"x12	10	350
<b>F300CR005</b>	M1/2"x14	10	250

**F301**

Raccordo giunzione MF  
*Joint fitting MF*





CROMATO LUCIDO   CHROME-POLISHED			
CODICE CODE	MISURA SIZE		
<b>F301CR001</b>	F3/8"x10	10	400
<b>F301CR002</b>	F3/8"x12	10	400
<b>F301CR005</b>	F1/2"x10	10	350
<b>F301CR006</b>	F1/2"x12	10	350
<b>F301CR007</b>	F1/2"x14	10	250

**F302**

Raccordo diritto doppio MM  
*Double straight fitting MM*



## CROMATO LUCIDO | CHROME-POLISHED



CODICE CODE	MISURA SIZE		
F302CR001	10x10	10	350
F302CR003	12x12	10	350
F302CR004	14x14	10	250

**F53**

Nipples M prolungato con rosone e dado  
*Male extended nipples with rosette and nut*



## CROMATO LUCIDO | CHROME-POLISHED



CODICE CODE	MISURA SIZE		
F53CR001	1/2"x10	1	250
F53CR002	1/2"x12	1	250
F53CR003	1/2"x14	1	200

**F57**

Nipples M ridotto prolungato con rosone senza dado  
*Male extended nipples with rosette without nut*



## CROMATO LUCIDO | CHROME-POLISHED



CODICE CODE	MISURA SIZE		
F57CR002	1/2"x3/8"	1	100

**F152**

Nipples ridotto prolungato MM  
*Reduced extended nipples MM*



## CROMATO LUCIDO | CHROME-PLATED



CODICE CODE	MISURA SIZE		
F152CR001	1/2"x3/8"	10	300

**F303**

Raccordo curvo giunzione  
*Elbow joint fitting*



## CROMATO LUCIDO | CHROME-PLATED



CODICE CODE	MISURA SIZE		
<b>F303CR001</b>	10x10	10	200
<b>F303CR002</b>	12x12	10	200

**F134**

Raccordo "Y" FFM  
*"Y" Joint FFM*



## CROMATO LUCIDO | CHROME-PLATED

CODICE CODE	MISURA SIZE		
<b>F134CR001</b>	1/2"	10	100

**F126**

Raccordo "Y" FFF  
*"Y" Joint FFF*



## CROMATO LUCIDO | CHROME-PLATED



CODICE CODE	MISURA SIZE		
<b>F126CR001</b>	1/2"	10	150

**F6**

RACCORDO A 90° CON PLACCA  
*90° JOINT WITH PLATE*



## CROMATO LUCIDO | CHROME-PLATED

CODICE CODE	MISURA SIZE		
<b>F6CR001</b>	1/2"Fx3/8" M Ø10	10	-
<b>F6CR003</b>	1/2"Fx1/2" M Ø12	10	-
<b>F6CR004</b>	1/2"Fx1/2" M Ø14	10	-





**F171**

Gomito flangiato per tubo rame  
*Flanged elbow for copper pipe*



## CROMATO LUCIDO | CHROME-PLATED



CODICE CODE	MISURA SIZE		
F171CR001	F1/2"x10	10	-
F171CR002	F1/2"x12	10	-
F171CR003	F1/2"x14	10	-

**F100**

Riduzione sottolavello MF  
*Sink reduction MF*



## CROMATO LUCIDO | CHROME-PLATED



CODICE CODE	MISURA SIZE		
F100CR001	1"Mx1"1/4F	10	100
F100CR002	1"1/4Mx1"1/2F	10	80

**F51**

Tappo M con vite a incasso e rosone  
*Male plug with insert screw and  
 rosette*



## CROMATO | CHROME

CODICE CODE	MISURA SIZE		
F51CR001	3/8"	1	100
F51CR002	1/2"	1	150

**F52**

Tappo M con vite e rosone  
*Male plug with screw and rosette*



## CROMATO | CHROME



CODICE CODE	MISURA SIZE		
F52CR002	1/2"	1	75

**F169**

Prolunga per curvetta  
*Extension*



## CROMATO LUCIDO | CHROME-PLATED



CODICE CODE	MISURA SIZE		
F169CR002	3/8"x40	10	-

**F209**

Raccordo retrogruppo con dado girevole con foro  
*Rear group joint with swivel nut and hole*



## CROMATO LUCIDO | CHROME-PLATED

CODICE CODE	MISURA SIZE		
F209CR001	3/4"Mx1/2"Fx3/4"F	10	-

**F208**

Raccordo retrogruppo con dado girevole senza foro  
*Rear group joint with swivel nut without hole*



## CROMATO LUCIDO | CHROME-PLATED



CODICE CODE	MISURA SIZE		
F208CR001	3/4"Fx3/4"M	10	140

**F210**

Raccordo retrogruppo con dado girevole con foro  
*Rear group joint with swivel nut and hole*



## CROMATO LUCIDO | CHROME-PLATED

CODICE CODE	MISURA SIZE		
F210CR001	3/4" Mx3/8" Fx3/4" F	10	-

**F211**

Raccordo retrogruppo con dado girevole senza foro  
*Rear group joint with swivel nut without hole*



## CROMATO LUCIDO | CHROME-PLATED



CODICE CODE	MISURA SIZE		
F211CR001	3/4" Mx3/4" F	10	140

**F212**

Raccordo retrogruppo con foro  
*Rear group joint with hole*



## CROMATO LUCIDO | CHROME-PLATED



CODICE CODE	MISURA SIZE		
F212CR001	3/4" Mx3/8" Fx3/4" F	10	150

**F213**

Raccordo retrogruppo senza foro  
*Rear group joint without hole*





## CROMATO LUCIDO | CHROME-PLATED



CODICE CODE	MISURA SIZE		
F213CR001	3/4" Mx3/4" F	10	150

### F13

Raccordo portagomma M  
Connection for hose M





GIALLO   YELLOW			
CODICE CODE	MISURA SIZE		
F13R002	1/8"x8	25	800
F13R003	1/8"x10	25	800
F13R004	1/4"x6	25	700
F13R005	1/4"x8	25	700
F13R006	1/4"x10	25	700
F13R007	1/4"x13	25	700
F13R008	3/8"x10	25	500
F13R009	3/8"x13	25	500
F13R010	3/8"x15	25	400
F13R011	1/2"x10	25	400
F13R012	1/2"x13	25	350
F13R013	1/2"x15	25	350
F13R014	1/2"x16	25	300
F13R015	1/2"x18	25	300
F13R016	1/2"x20	25	250
F13R018	3/4"x16	10	160
F13R019	3/4"x18	10	200
F13R020	3/4"x20	10	140
F13R021	3/4"x22	10	150
F13R022	3/4"x25	10	120



GIALLO   YELLOW			
CODICE CODE	MISURA SIZE		
F13R024	1"x25	10	100
F13R025	1"x27	10	100
F13R026	1"x30	10	80
F13R027	1"x32	10	80
F13R028	1"1/4x30	10	60
F13R029	1"1/4x32	10	60
F13R030	1"1/4x35	10	50
F13R032	1"1/4x40	10	50
F13R034	1"1/2x40	10	40
F13R035	1"1/2x45	10	40
F13R036	1"1/2x50	10	30
F13R037	2"x50	5	25
F13R039	2"x60	5	20
F13R044	3"x80	5	10
F13R045	4"x100	2	8

### F14

Raccordo portagomma F  
Connection for hose F





GIALLO   YELLOW			
CODICE CODE	MISURA SIZE		
F14R000	1/8"x8	25	1.500
F14R003	1/4"x10	25	1.000
F14R006	3/8"x13	25	950
F14R008	1/2"x10	25	400
F14R009	1/2"x13	25	400
F14R023	1/2"x14	25	300
F14R010	1/2"x15	25	300
F14R021	1/2"x16	25	300
F14R011	1/2"x18	25	300

GIALLO   YELLOW			
CODICE CODE	MISURA SIZE		
F14R012	3/4"x20	10	160
F14R013	3/4"x25	10	160
F14R014	1"x25	10	100
F14R015	1"x30	10	80
F14R016	1"1/4x30	15	50
F14R018	1"1/4x35	15	50
F14R019	1"1/2x40	15	35
F14R020	2"x50	5	10

### F17

Raccordo portagomma diritto  
3 pezzi  
3 pieces straight connection hose





GIALLO   YELLOW			
CODICE CODE	MISURA SIZE		
F17R002	1/2"x15	10	350
F17R003	1/2"x18	10	250
F17R005	3/4"x20	10	250
F17R006	3/4"x25	10	130
F17R007	1"x25	10	120
F17R008	1"x30	10	80
F17R012	1"1/4x35	10	60
F17R014	1"1/2x40	10	50
F17R016	2"x50	5	25



**F29**

Raccordo portagomma M Ø13

metano

*Hose connection for methane Ø13 M*

GIALLO   YELLOW			
CODICE CODE	MISURA SIZE		
F29R001	3/8"	10	-
F29R002	1/2"	10	-



CROMATO   CHROME			
CODICE CODE	MISURA SIZE		
F29CR001	3/8"	10	-
F29CR002	1/2"	10	-



**F30**

Raccordo portagomma F Ø13

metano

*Hose connection for methane Ø13 F*



GIALLO   YELLOW			
CODICE CODE	MISURA SIZE		
F30R001	3/8"	10	-
F30R002	1/2"	10	-



CROMATO   CHROME			
CODICE CODE	MISURA SIZE		
F30CR001	3/8"	10	-
F30CR002	1/2"	10	-

**F31**

Raccordo portagomma M Ø8 GPL

*Hose connection for GPL Ø8 M*



GIALLO   YELLOW			
CODICE CODE	MISURA SIZE		
F31R001	3/8"	10	-
F31R002	1/2"	10	-



CROMATO   CHROME			
CODICE CODE	MISURA SIZE		
F31CR001	3/8"	10	-
F31CR002	1/2"	10	-

**F32**

Raccordo portagomma F Ø8 GPL

*Hose connection for GPL Ø8 F*



GIALLO   YELLOW			
CODICE CODE	MISURA SIZE		
F32R001	3/8"	10	-
F32R002	1/2"	10	-

CROMATO   CHROME			
CODICE CODE	MISURA SIZE		
F32CR001	3/8"	10	-
F32CR002	1/2"	10	-

## F21

Gomito portagomma M  
Elbow connection hose M





GIALLO   YELLOW			
CODICE CODE	MISURA SIZE		
F21R003	3/8"x10	25	300
F21R001	3/8"x15	25	250
F21R004	1/2"x10	20	200
F21R002	1/2"x15	20	200

CROMATO SABBBIATO   SANDBLASTED-CHROME			
CODICE CODE	MISURA SIZE		
F21CR003	3/8"x10	25	300
F21CR001	3/8"x15	25	250
F21CR004	1/2"x10	20	200
F21CR002	1/2"x15	20	200

## F22

Gomito portagomma F  
Elbow connection hose F





GIALLO   YELLOW			
CODICE CODE	MISURA SIZE		
F22R003	3/8"x10	25	300
F22R001	3/8"x15	25	200
F22R004	1/2"x10	20	200
F22R002	1/2"x15	20	200

CROMATO SABBBIATO   SANDBLASTED-CHROME			
CODICE CODE	MISURA SIZE		
F22CR003	3/8"x10	25	300
F22CR001	3/8"x15	25	200
F22CR004	1/2"x10	20	200
F22CR002	1/2"x15	20	200

## F166

Piletta svizzera  
Swiss waste



GIALLO   YELLOW			
CODICE CODE	MISURA SIZE		
F166R001	3/4"	10	-
F166R002	1"	10	-
F166R003	1"1/4	10	-
F166R004	1"1/2	10	-
F166R005	2"	5	-

### SAPEVATE CHE... DO YOU KNOW...

I nostri prodotti sono più pesanti per garantire una lunga tenuta nel tempo.



*Our products are heavier to guarantee a longer lasting resistance.*



**F403**

Piletta per cassone con filetto interno  
*Tank waste with internal thread*





GIALLO   YELLOW			
CODICE CODE	MISURA SIZE		
F403R001	1/2"	10	120
F403R002	3/4"	10	80
F403R003	1"	5	50
F403R004	1"1/4	5	30
F403R005	1"1/2	5	20

**F405**

Piletta per cassone con filetto interno completa di codolo con guarnizione  
*Tank waste with internal thread complete with tang and gasket*





GIALLO   YELLOW			
CODICE CODE	MISURA SIZE		
F405R001	1/2"	10	60
F405R002	3/4"	10	50
F405R003	1"	5	30
F405R004	1"1/4	5	20
F405R005	1"1/2	5	10

**F401**

Raccordo per cassone  
*Tank fitting with gasket*



GIALLO   YELLOW			
CODICE CODE	MISURA SIZE		
F401R001	1/2"	10	50
F401R002	3/4"	10	40
F401R003	1"	10	40
F401R004	1"1/4	10	20
F401R005	1"1/2	5	15
F401R006	2"	5	10

**F404**

Prolunga per piletta tutto filetto  
*Full threaded extension for tank waste*





GIALLO   YELLOW			
CODICE CODE	MISURA SIZE		
F404R002	3/4"-10 cm	5	-
F404R003	1"-10 cm	5	-

**F200**

Dado per condizionatore  
*Nut for air conditioner*





GIALLO   YELLOW			
CODICE CODE	MISURA SIZE		
F200R001	1/4"	10	-
F200R002	3/8"	10	-
F200R003	1/2"	10	-
F200R004	5/8"	10	-
F200R005	3/4"	10	-

**F218**

Dado ridotto per condizionatore  
*Reduced nut for air conditioner*





GIALLO   YELLOW			
CODICE CODE	MISURA SIZE		
F218R001	3/8"x1/4"	10	-
F218R002	1/2"x3/8"	10	-
F218R003	5/8"x1/2"	10	-

**F201**

Nipples doppio per condizionatore  
*Double nipples for air conditioner*





GIALLO   YELLOW			
CODICE CODE	MISURA SIZE		
F201R001	1/4"	10	-
F201R002	3/8"	10	-
F201R003	1/2"	10	-
F201R004	5/8"	10	-
F201R005	3/4"	10	-

**F202**

Nipples ridotto per condizionatore  
*Reduced nipples for air conditioner*





GIALLO   YELLOW			
CODICE CODE	MISURA SIZE		
F202R001	1/4"x3/8"	10	-
F202R002	3/8"x1/2"	10	-
F202R003	1/2"x5/8"	10	-
F202R004	5/8"x3/4"	10	-
F202R005	1/2"x1/4"	10	-

**F203**

Prolunga ridotta per condizionatore  
*Reduced extension for air conditioner*







GIALLO   YELLOW			
CODICE CODE	MISURA SIZE		
F203R000	F1/2"x1/4"M	10	-
F203R001	F1/2"x3/8"M	10	-
F203R002	F3/8"x1/2"M	10	-
F203R003	F3/8"x1/4"M	10	-
F203R004	F1/4"x3/8"M	10	-

**F168**

Raccordo per pompe circolatori FF  
FF Fitting for circulation pump





GIALLO   YELLOW			
CODICE CODE	MISURA SIZE		
F168R001	1/2"x cal. 1"	2	50
F168R002	1/2"x cal. 1"1/2	2	50
F168R003	3/4"x cal. 1"1/4	2	40
F168R004	3/4"x cal. 1"1/2	2	50
F168R005	1"x cal. 1"1/2	2	50
F168R006	1"1/4x cal. 2"	2	40
F168R007	1"1/2x cal. 2"1/4	2	40
F168R008	2"x cal. 2"3/4	2	30



CROMATO   CHROME			
CODICE CODE	MISURA SIZE		
F168CR001	1/2"x cal. 1"	2	50
F168CR002	1/2"x cal. 1"1/2	2	50
F168CR003	3/4"x cal. 1"1/4	2	40
F168CR004	3/4"x cal. 1"1/2	2	50
F168CR005	1"x cal. 1"1/2	2	50
F168CR006	1"1/4x cal. 2"	2	40
F168CR007	1"1/2x cal. 2"1/4	2	40
F168CR008	2"x cal. 2"3/4	2	30

**F622**

Codolo sede piana pesante MF,  
con calotta  
Tail flat heavy seat MF, with cap





GIALLO   YELLOW			
CODICE CODE	MISURA SIZE		
F622R003	1/2"x cal. 3/4"	10	200
F622R004	3/4"x cal. 1"	10	100
F622R005	1"x cal. 1"1/4	5	50
F622R006	1"1/4x cal. 1"1/2	5	30
F622R007	1"1/2x cal. 2"	5	25
F622R008	2"x cal. 2"1/2	5	15



CROMATO   CHROME			
CODICE CODE	MISURA SIZE		
F622CR003	1/2"x cal. 3/4"	10	200
F622CR004	3/4"x cal. 1"	10	100
F622CR005	1"x cal. 1"1/4	5	50

**F622**

Codolo con sede piana con inserto MF  
Tail flat seat with insert MF





GIALLO   YELLOW			
CODICE CODE	MISURA SIZE		
F622R002	1/2" Mx 1/2" F	10	200
F622R009	3/4" Mx 3/4" F	10	150

CROMATO LUCIDO   CHROME-PLATED			
CODICE CODE	MISURA SIZE		
F622CR002	1/2" Mx 1/2" F	10	200
F622CR009	3/4" Mx 3/4" F	10	150

**F191**

Codolo per contatore MF  
Flat seat heavy tail MF







GIALLO   YELLOW			
CODICE CODE	MISURA SIZE		
F191R000	3/8"x cal. 3/4"	1	75
F191R001	1/2"x cal. 3/4"	1	75
F191R002	3/4"x cal. 1"	1	50
F191R003	1"x cal. 1"1/4	1	30
F191R004	1"1/4x cal. 1"1/2	1	25
F191R005	1"1/2x cal. 2"	1	20
F191R006	2"x cal. 2"1/2	1	10

**F554**

Terminale per collettori con doppio attacco radiale, in ottone, con autotenuta  
*Terminal end for manifolds with double radial connection, in brass, with latching*





GIALLO   YELLOW			
CODICE CODE	MISURA SIZE		
F554R002	1"x1/2"x3/8"	1	80

CROMATO SABBATO   SANDBLASTED-CHROME			
CODICE CODE	MISURA SIZE		
F554CR002	1"x1/2"x3/8"	1	80

**F571**

Gomito 105° F per tubo pex con attacco portagomma  
*Elbow 105° F for multilayer pipe w/insert*



GIALLO   YELLOW			
CODICE CODE	MISURA SIZE		
F571R002	F1/2x16x2mm	1	-

**F559**

Gomito 105° prolungato F  
*105° Extended elbow F*





GIALLO   YELLOW			
CODICE CODE	MISURA SIZE		
F559R001	F1/2x1/2M 16x2mm	1	75

**F541**

Adattatore multistrato con ogiva e calotta  
*Insert with nut and ring for multilayer pipe*



CROMATO   CHROME			
CODICE CODE	MISURA SIZE		
F541CR001	16x2	1	150
F541CR003	20x2	1	150
F541CR005	25x2,3	1	150
F541CR006	25x2,5	1	150
F541CR007	26x3	1	150
F541CR004	32x3	1	150





FP PATTARONI

MADE IN ITALY

**COLLETTORI E  
ARREDOVALVOLE  
MANIFOLDS AND  
VALVE FURNITURE**





COLLETTORI E ARREDOVALVOLE  
MANIFOLDS AND VALVE FURNITURE

**F517**

Raccordo per tubo multistrato

M con inserto

*Fitting for multilayer pipe M with insert*



CROMATO   CHROME			
CODICE CODE	MISURA SIZE MM		
F517CR002	1/2"x16x2	10	100
F517CR004	1/2"x20x2	10	150
F517CR009	1/2"x20x2,5	10	150
F517CR005	3/4"x20x2	10	100
F517CR013	3/4"x25x2,3	10	100
F517CR016	3/4"x25x2,5	10	100
F517CR006	3/4"x26x3	10	100
F517CR014	1"x25x2,3	10	50
F517CR007	1"x26x3	10	50
F517CR008	1"x32x3	10	50

**F518**

Raccordo per tubo multistrato F

con inserto

*Fitting for multilayer pipe F with insert*



CROMATO   CHROME			
CODICE CODE	MISURA SIZE MM		
F518CR002	1/2"x16x2	10	200
F518CR004	1/2"x20x2	10	150
F518CR009	1/2"x20x2,5	10	150
F518CR005	3/4"x20x2	10	100
F518CR014	3/4"x20x2,5	10	100
F518CR015	3/4"x25x2,5	10	100
F518CR006	3/4"x26x3	10	100
F518CR011	1"x25x2,3	10	50
F518CR007	1"x26x3	10	50
F518CR008	1"x32x3	10	50

**F519**

Raccordo diritto per tubo multistrato

con inserto doppio

*Straight double fitting for multilayer pipe with insert*



CROMATO   CHROME			
CODICE CODE	MISURA SIZE MM		
F519CR001	16x16x2	10	80
F519CR002	20x20x2	10	100
F519CR006	20x20x2,5	10	100
F519CR009	25x25x2,3	10	50
F519CR010	25x25x2,5	10	50
F519CR003	26x26x3	10	50
F519CR004	32x32x3	10	50

**F520**

Gomito doppio per tubo multistrato

con inserto

*Double elbow for multilayer pipe with insert*

CROMATO   CHROME			
CODICE CODE	MISURA SIZE MM		
F520CR001	16x16x2	10	150
F520CR002	20x20x2	10	100
F520CR008	20x20x2,5	10	100
F520CR006	25x25x2,3	10	100
F520CR009	25x25x2,5	10	100
F520CR003	26x26x3	10	50
F520CR004	32x32x3	10	50

### F521

Gomito per tubo multistrato M cromato sabbiato con inserto  
*Male elbow for multilayer pipe sandblasted-chrome with insert*



CROMATO   CHROME			
CODICE CODE	MISURA SIZE MM		
F521CR001	1/2"x16x2	10	150
F521CR003	1/2"x20x2	10	150
F521CR012	1/2"x20x2,5	10	150
F521CR004	3/4"x20x2	10	100
F521CR016	3/4"x20x2,5	10	100

CROMATO   CHROME			
CODICE CODE	MISURA SIZE MM		
F521CR009	3/4"x25x2,3	10	100
F521CR020	3/4"x25x2,5	10	100
F521CR005	3/4"x26x3	10	100
F521CR010	1"x25x2,3	10	50
F521CR006	1"x26x3	10	50
F521CR007	1"x32x3	10	50

### F522

Gomito per tubo multistrato F con inserto  
*Female elbow for multilayer pipe with insert*



CROMATO   CHROME			
CODICE CODE	MISURA SIZE MM		
F522CR001	1/2"x16x2	10	150
F522CR003	1/2"x20x2	10	150
F522CR011	1/2"x20x2,5	10	150
F522CR004	3/4"x20x2	10	100
F522CR016	3/4"x20x2,5	10	100

CROMATO   CHROME			
CODICE CODE	MISURA SIZE MM		
F522CR009	3/4"x25x2,3	10	100
F522CR012	3/4"x25x2,5	10	100
F522CR005	3/4"x26x3	10	100
F522CR010	1"x25x2,3	10	50
F522CR006	1"x26x3	10	50
F522CR007	1"x32x3	10	50

### F523

Raccordo TEE per tubo multistrato con inserto  
*TEE for multilayer pipe with insert*



CROMATO   CHROME			
CODICE CODE	MISURA SIZE MM		
F523CR001	16x16x16x2	10	100
F523CR002	20x20x20x2	10	100
F523CR008	20x20x20x2,5	10	100
F523CR006	25x25x25x2,3	10	100
F523CR003	26x26x26x3	10	50
F523CR004	32x32x32x3	10	50

### F524

Raccordo TEE per tubo multistrato F con inserto  
*Female TEE for multilayer pipe with insert*



CROMATO   CHROME			
CODICE CODE	MISURA SIZE MM		
F524CR001	16x16x2 x1/2"	10	100
F524CR002	20x20x2 x1/2"	10	100
F524CR003	20x20x2 x3/4"	10	100
F524CR008	20x20x2,5 x1/2"	10	100

CROMATO   CHROME			
CODICE CODE	MISURA SIZE MM		
F524CR009	20x20x2,5 x3/4"	10	100
F524CR007	25x25x2,3 x3/4"	10	100
F524CR004	26x26x3 x3/4"	10	100
F524CR005	26x26x3 x1"	10	50
F524CR006	32x32x3 x1"	10	50

### F525

Raccordo TEE con inserto per tubo multistrato M  
*Male TEE with insert for multilayer pipe*



CROMATO   CHROME			
CODICE CODE	MISURA SIZE MM		
F525CR001	16x16x2x1/2"	10	100
F525CR002	20x20x2x1/2"	10	100
F525CR003	20x20x2x3/4"	10	100
F525CR009	20x20x2,5x3/4"	10	100



CROMATO   CHROME			
CODICE CODE	MISURA SIZE MM		
F525CR007	25x25x2,3x3/4"	10	100
F525CR004	26x26x3x3/4"	10	100
F525CR005	26x26x3x1"	10	50
F525CR006	32x32x3x1"	10	50

**F527**

Nipples M in ottone cromato, attacco 24x19 tubo rame, plastica e multistrato

*Chromed brass male fitting connection 24x19 for copper, plastic and multilayer pipe*





CROMATO   CHROME			
CODICE CODE	MISURA SIZE		
<b>F527CR002</b>	1/2"	50	250
<b>F527CR003</b>	3/4"	50	250
<b>F527CR004</b>	1"	25	125

**F528**

Nipples F in ottone cromato, attacco 24x19 tubo rame, plastica e multistrato

*Chromed brass female fitting connection 24x19 for copper, plastic and multilayer pipe*





CROMATO   CHROME			
CODICE CODE	MISURA SIZE		
<b>F528CR002</b>	1/2"	50	250
<b>F528CR003</b>	3/4"	50	250
<b>F528CR004</b>	1"	25	125

**F529**

Nipples doppio in ottone cromato, attacco 24x19 tubo rame, plastica e multistrato

*Chromed brass double fitting connection 24x19 for copper, plastic and multilayer pipe*





CROMATO   CHROME			
CODICE CODE	MISURA SIZE		
<b>F529CR001</b>	24x19	25	250

**F530**

Raccordo curvo in ottone cromato, attacco 24x19 tubo rame, plastica e multistrato

*Chromed brass elbow fitting connection 24x19 for copper, plastic and multilayer pipe*





CROMATO   CHROME			
CODICE CODE	MISURA SIZE		
<b>F530CR001</b>	24x19	25	125

**F531**

Raccordo curvo M in ottone cromato, attacco 24x19 tubo rame, plastica e multistrato  
*Chromed brass male elbow fitting connection 24x19 for copper, plastic and multilayer pipe*





CROMATO   CHROME			
CODICE CODE	MISURA SIZE		
F531CR001	1/2"	25	125
F531CR002	3/4"	25	125

**F532**

Raccordo curvo F in ottone cromato, attacco 24x19 tubo rame, plastica e multistrato  
*Chromed brass female elbow fitting connection 24x19 for copper, plastic and multilayer pipe*





CROMATO   CHROME			
CODICE CODE	MISURA SIZE		
F532CR002	1/2"	25	125
F532CR003	3/4"	25	125

**F533**

Raccordo curvo F flangiato in ottone cromato, attacco 24x19 tubo rame, plastica e multistrato  
*Chromed brass female wall bearing elbow fitting connection 24x19 for copper, plastic and multilayer pipe*





CROMATO   CHROME			
CODICE CODE	MISURA SIZE		
F533CR001	1/2"	25	125

**F534**

Raccordo TEE M in ottone cromato, 2 attacchi 24x19 tubo rame, plastica e multistrato  
*Chromed brass TEE fitting M with 2 connection 24x19 for copper, plastic and multilayer pipe*





CROMATO   CHROME			
CODICE CODE	MISURA SIZE		
F534CR002	1/2"	25	125
F534CR003	3/4"	25	125

**F535**

Raccordo TEE M in ottone cromato, 2 attacchi  
 24x19 tubo rame, plastica e multistrato  
*Chromed brass TEE fitting M, with 2 connections  
 24x19 for copper, plastic and multilayer pipe*





CROMATO   CHROME			
CODICE CODE	MISURA SIZE		
<b>F535CR001</b>	1/2"	25	125

**F536**

3 attacchi 24x19 tubo rame, plastica e multistrato  
*Chromed brass TEE fitting M, with 3 connections 24x19  
 for copper, plastic and multilayer pipe*





CROMATO   CHROME			
CODICE CODE	MISURA SIZE		
<b>F536CR001</b>	24x19	25	125

**F537**

Raccordo TEE F in ottone cromato, 2 attacchi  
 24x19 tubo rame, plastica e multistrato  
*Chromed brass TEE fitting F, with 2 connections  
 24x19 for copper, plastic and multilayer pipe*



CROMATO   CHROME			
CODICE CODE	MISURA SIZE		
<b>F537CR002</b>	1/2"	25	125
<b>F537CR003</b>	3/4"	25	125

**F3001**

Collettori di distribuzione, in ottone con attacchi filettati femmina.

Interasse mm. 50

*Distribution manifolds, made of brass, threaded. Wheelbase mm. 50*



GIALLO   YELLOW				DATI TECNICI   TECHNICAL DATA	
CODICE CODE	MISURA SIZE			PRESSIONE MASSIMA MAXIMUM PRESSURE	TEMPERATURA MINIMA / MASSIMA MINIMUM / MAXIMUM TEMPERATURE
F3001R002	1"x1/2" / 2	1	40	16 bar	5/110° C
F3001R003	1"x1/2" / 3	1	24	16 bar	5/110° C
F3001R004	1"x1/2" / 4	1	20	16 bar	5/110° C
F3001R005	1"x1/2" / 5	1	20	16 bar	5/110° C
F3001R006	1"x1/2" / 6	1	20	16 bar	5/110° C
F3001R007	1"x1/2" / 7	1	10	16 bar	5/110° C
F3001R008	1"x1/2" / 8	1	10	16 bar	5/110° C
F3001R009	1"x1/2" / 9	1	10	16 bar	5/110° C
F3001R010	1"x1/2" / 10	1	10	16 bar	5/110° C
F3001R011	1"x1/2" / 11	1	10	16 bar	5/110° C
F3001R012	1"x1/2" / 12	1	10	16 bar	5/110° C

**F3002**

Collettori di distribuzione, in ottone con attacchi filettati femmina.

Interasse mm. 50

*Distribution manifolds, made of brass, threaded. Wheelbase mm. 50*



GIALLO   YELLOW				DATI TECNICI   TECHNICAL DATA	
CODICE CODE	MISURA SIZE			PRESSIONE MAX MAX. PRESSURE	TEMPERATURA MAX MAX. TEMPERATURE
F3002R002	1"1/4x1/2" / 2	1	32	16 bar	5/110° C
F3002R003	1"1/4x1/2" / 3	1	16	16 bar	5/110° C
F3002R004	1"1/4x1/2" / 4	1	16	16 bar	5/110° C
F3002R005	1"1/4x1/2" / 5	1	16	16 bar	5/110° C
F3002R006	1"1/4x1/2" / 6	1	16	16 bar	5/110° C
F3002R007	1"1/4x1/2" / 7	1	8	16 bar	5/110° C
F3002R008	1"1/4x1/2" / 8	1	8	16 bar	5/110° C
F3002R009	1"1/4x1/2" / 9	1	8	16 bar	5/110° C
F3002R010	1"1/4x1/2" / 10	1	8	16 bar	5/110° C
F3002R011	1"1/4x1/2" / 11	1	8	16 bar	5/110° C
F3002R012	1"1/4x1/2" / 12	1	8	16 bar	5/110° C

**F517**

Raccordo per tubo multistrato M con inserto

*Fitting for multilayer pipe M with insert*



CROMATO   CHROME			
CODICE CODE	MISURA SIZE MM		
F517CR002	1/2"x16x2	1	-
F517CR004	1/2"x20x2	1	-

**F543**

Adattatore 3/4" Eurocono per collettori da barra Eurocone adapter 3/4 for bar manifold



GIALLO   YELLOW				CROMATO   CHROME			
CODICE CODE	MISURA SIZE			CODICE CODE	MISURA SIZE		
F543R001	3/4"x1/2"	1	150	F543CR001	3/4"x1/2"	1	150

## D-MFH

Monoforo alto per lavabo in appoggio H260

*Sleeve basin mixer*



**RICHIEDI IL CATALOGO DELLA RUBINETTERIA  
REQUEST TAP CATALOGUE**



COLLETTORI E ARREDOVALVOLE  
MANIFOLDS AND VALVE FURNITURE



FP PATTARONI

MADE IN ITALY

## FINITURE SUPERFICIALI METALLIZZATE E COLORATE METALIZED AND COLORED FINISHES



**CLL**  
cromo  
chrome



**MB**  
bronzo spazzolato  
brushed bronze



**MA**  
acciaio spazzolato  
brushed steel



**MR**  
rame spazzolato  
brushed copper



**MC**  
cromo spazzolato  
brushed chrome



**MS**  
cromo satinato  
satin chrome



**MN**  
nichel satinato  
satin nickel



**NA**  
nero antracite  
black anthracite



**NO**  
nero opaco  
matt black





**CTB**  
bianco 9010  
white 9010

**F3900**









Valvola a squadra termostattizzabile con monopola in ottone

*Angle valve with brass handle and thermostatic option*



F3900					
CODICE CODE	FINITURA FINISH	MISURA SIZE			
<b>F3901CHT</b>	Cromo / Chrome	1/2"	1	30	
<b>F3902MB</b>	Bronzo spazzolato / Brushed bronze	1/2"	1	30	
<b>F3903MA</b>	Acciaio spazzolato / Brushed steel	1/2"	1	30	
<b>F3904MR</b>	Rame spazzolato / Brushed copper	1/2"	1	30	
<b>F3905MC</b>	Cromo spazzolato / Brushed chrome	1/2"	1	30	
<b>F3906MS</b>	Cromo satinato / Satin chrome	1/2"	1	30	
<b>F3907MN</b>	Nichel satinato / Satin nickel	1/2"	1	30	
<b>F3908NA</b>	Nero antracite / Black anthracite	1/2"	1	30	
<b>F3909NO</b>	Nero opaco / Matt black	1/2"	1	30	
<b>F3910CTB</b>	Bianco 9010 / White 9010	1/2"	1	30	



									
CHT	MB	MA	MR	MC	MS	MN	NA	NO	CTB

**F4000**

Valvola a squadra termostattizzabile con monopola in ABS

*Angle valve with ABS handle and thermostatic option*



F4000					
CODICE CODE	FINITURA FINISH	MISURA SIZE			
<b>F4000CHT</b>	Cromo / Chrome	1/2"	1	30	



CHT

**F4100**





Valvola a squadra termostattizzabile con cappuccio in ABS bianco

*Angle valve with white ABS cup and thermostatic option*



F4100					
CODICE CODE	FINITURA FINISH	MISURA SIZE			
<b>F4101CHT</b>	Cromo / Chrome	1/2"	1	30	
<b>F4102MB</b>	Bronzo spazzolato / Brushed bronze	1/2"	1	30	
<b>F4103MA</b>	Acciaio spazzolato / Brushed steel	1/2"	1	30	
<b>F4104MR</b>	Rame spazzolato / Brushed copper	1/2"	1	30	
<b>F4105MC</b>	Cromo spazzolato / Brushed chrome	1/2"	1	30	
<b>F4106MS</b>	Cromo satinato / Satin chrome	1/2"	1	30	
<b>F4107MN</b>	Nichel satinato / Satin nickel	1/2"	1	30	
<b>F4108NA</b>	Nero antracite / Black anthracite	1/2"	1	30	
<b>F4109NO</b>	Nero opaco / Matt black	1/2"	1	30	
<b>F4110CTB</b>	Bianco 9010 / White 9010	1/2"	1	30	

									
CHT	MB	MA	MR	MC	MS	MN	NA	NO	CTB

**F4150**

Detentore a squadra  
Angle lockshield

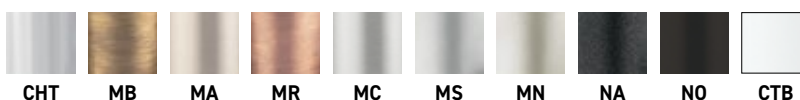

F4150				
CODICE CODE	FINITURA FINISH	MISURA SIZE		
F4151CHT	Cromo / Chrome	1/2"	1	30
F4152MB	Bronzo spazzolato / Brushed bronze	1/2"	1	30
F4153MA	Acciaio spazzolato / Brushed steel	1/2"	1	30
F4154MR	Rame spazzolato / Brushed copper	1/2"	1	30
F4155MC	Cromo spazzolato / Brushed chrome	1/2"	1	30
F4156MS	Cromo satinato / Satin chrome	1/2"	1	30
F4157MN	Nichel satinato / Satin nickel	1/2"	1	30
F4158NA	Nero antracite / Black anthracite	1/2"	1	30
F4159NO	Nero opaco / Matt black	1/2"	1	30
F4160CTB	Bianco 9010 / White 9010	1/2"	1	30

**F4250**

Valvola ad angolo versione sinistra  
termostattabile con monopola in ottone  
Left angle valve with brass handle and  
thermostatic option



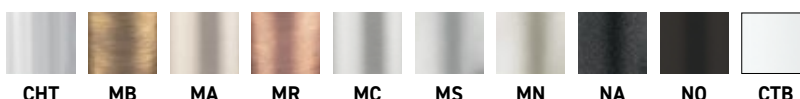

F4250				
CODICE CODE	FINITURA FINISH	MISURA SIZE		
F4251CHT	Cromo / Chrome	1/2"	1	30
F4252MB	Bronzo spazzolato / Brushed bronze	1/2"	1	30
F4253MA	Acciaio spazzolato / Brushed steel	1/2"	1	30
F4254MR	Rame spazzolato / Brushed copper	1/2"	1	30
F4255MC	Cromo spazzolato / Brushed chrome	1/2"	1	30
F4256MS	Cromo satinato / Satin chrome	1/2"	1	30
F4257MN	Nichel satinato / Satin nickel	1/2"	1	30
F4258NA	Nero antracite / Black anthracite	1/2"	1	30
F4259NO	Nero opaco / Matt black	1/2"	1	30
F4260CTB	Bianco 9010 / White 9010	1/2"	1	30

**F4300**

Valvola ad angolo versione sinistra  
termostattabile con monopola in ABS  
Left angle valve with ABS handle and  
thermostatic option



F4300				
CODICE CODE	FINITURA FINISH	MISURA SIZE		
F4301CHT	Cromo / Chrome	1/2"	1	30



**F4350**

Valvola ad angolo versione sinistra  
termostattabile con cappuccio in ABS  
bianco

*Left angle valve with white ABS cup and  
thermostatic option*



F4350				
CODICE CODE	FINITURA FINISH	MISURA SIZE		
F4351CLL	Cromo / Chrome	1/2"	1	30
F4352MB	Bronzo spazzolato / Brushed bronze	1/2"	1	30
F4353MA	Acciaio spazzolato / Brushed steel	1/2"	1	30
F4354MR	Rame spazzolato / Brushed copper	1/2"	1	30
F4355MC	Cromo spazzolato / Brushed chrome	1/2"	1	30
F4356MS	Cromo satinato / Satin chrome	1/2"	1	30
F4357MN	Nichel satinato / Satin nickel	1/2"	1	30
F4358NA	Nero antracite / Black anthracite	1/2"	1	30
F4359NO	Nero opaco / Matt black	1/2"	1	30
F4360CTB	Bianco 9010 / White 9010	1/2"	1	30

									
CLL	MB	MA	MR	MC	MS	MN	NA	NO	CTB



**F4400**

Detentore versione destra  
*Right angle lockshield*



F4400				
CODICE CODE	FINITURA FINISH	MISURA SIZE		
F4401CLS	Cromo / Chrome	1/2"	1	30
F4402MB	Bronzo spazzolato / Brushed bronze	1/2"	1	30
F4403MA	Acciaio spazzolato / Brushed steel	1/2"	1	30
F4404MR	Rame spazzolato / Brushed copper	1/2"	1	30
F4405MC	Cromo spazzolato / Brushed chrome	1/2"	1	30
F4406MS	Cromo satinato / Satin chrome	1/2"	1	30
F4407MN	Nichel satinato / Satin nickel	1/2"	1	30
F4408NA	Nero antracite / Black anthracite	1/2"	1	30
F4409NO	Nero opaco / Matt black	1/2"	1	30
F4410CTB	Bianco 9010 / White 9010	1/2"	1	30

									
CLS	MB	MA	MR	MC	MS	MN	NA	NO	CTB

**F4450**

Valvola ad angolo versione destra  
termostattabile con monopola in ottone  
*Angle radiator valves and lockshields  
with thermostatic option. Connection for  
copper, plastic and multilayer pipe*



F4450				
CODICE CODE	FINITURA FINISH	MISURA SIZE		
F4451CHT	Cromo / Chrome	1/2"	1	30
F4452MB	Bronzo spazzolato / Brushed bronze	1/2"	1	30
F4453MA	Acciaio spazzolato / Brushed steel	1/2"	1	30
F4454MR	Rame spazzolato / Brushed copper	1/2"	1	30
F4455MC	Cromo spazzolato / Brushed chrome	1/2"	1	30
F4456MS	Cromo satinato / Satin chrome	1/2"	1	30
F4457MN	Nichel satinato / Satin nickel	1/2"	1	30
F4458NA	Nero antracite / Black anthracite	1/2"	1	30
F4459NO	Nero opaco / Matt black	1/2"	1	30
F4460CTB	Bianco 9010 / White 9010	1/2"	1	30



  

									
CHT	MB	MA	MR	MC	MS	MN	NA	NO	CTB

**F4900**

Valvola ad angolo versione destra  
termostattabile con monopola in ABS  
*Right angle valve with ABS handle and  
thermostatic option*



F4900				
CODICE CODE	FINITURA FINISH	MISURA SIZE		
F4901CLS	Cromo / Chrome	1/2"	1	30



CLS

**F4500**

Valvola ad angolo versione sinistra  
termostattabile con cappuccio in ABS  
bianco  
*Right angle valve with white ABS cup and  
thermostatic option*



F4500				
CODICE CODE	FINITURA FINISH	MISURA SIZE		
F4501CLS	Cromo / Chrome	1/2"	1	30
F4502MB	Bronzo spazzolato / Brushed bronze	1/2"	1	30
F4503MA	Acciaio spazzolato / Brushed steel	1/2"	1	30
F4504MR	Rame spazzolato / Brushed copper	1/2"	1	30
F4505MC	Cromo spazzolato / Brushed chrome	1/2"	1	30
F4506MS	Cromo satinato / Satin chrome	1/2"	1	30
F4507MN	Nichel satinato / Satin nickel	1/2"	1	30
F4508NA	Nero antracite / Black anthracite	1/2"	1	30
F4509NO	Nero opaco / Matt black	1/2"	1	30
F4510CTB	Bianco 9010 / White 9010	1/2"	1	30

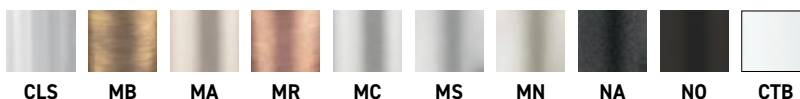

CLS

MB

MA

MR

MC

MS

MN

NA

NO

CTB

**F4550**

Detentore a squadra versione sinistra  
*Left angle lockshield*



F4550				
CODICE CODE	FINITURA FINISH	MISURA SIZE		
F4551CLS	Cromo / Chrome	1/2"	1	30
F4552MB	Bronzo spazzolato / Brushed bronze	1/2"	1	30
F4553MA	Acciaio spazzolato / Brushed steel	1/2"	1	30
F4554MR	Rame spazzolato / Brushed copper	1/2"	1	30
F4555MC	Cromo spazzolato / Brushed chrome	1/2"	1	30
F4556MS	Cromo satinato / Satin chrome	1/2"	1	30
F4557MN	Nichel satinato / Satin nickel	1/2"	1	30
F4558NA	Nero antracite / Black anthracite	1/2"	1	30
F4559NO	Nero opaco / Matt black	1/2"	1	30
F4560CTB	Bianco 9010 / White 9010	1/2"	1	30

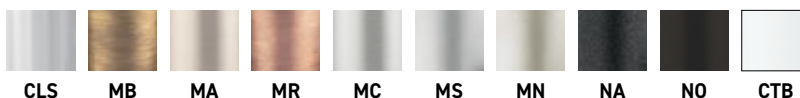

CLS

MB

MA

MR

MC

MS

MN

NA

NO

CTB



**F4600**

Valvola versione destra termostattabile  
con manopola in ABS

*Valve right version with thermostatic  
option and ABS handle*



CHT

**F4600**

CODICE CODE	FINITURA FINISH	MISURA SIZE		
<b>F4601CHT</b>	Cromo / Chrome	1/2"	1	30

**F4650**

Valvola versione destra termostattabile  
con cappuccio in ABS bianco

*Valve right version with thermostatic  
option and white ABS cup*

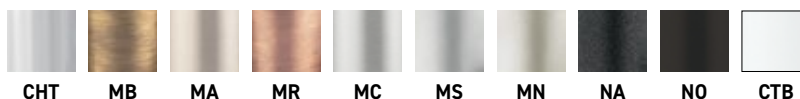

CHT

MB

MA

MR

MC

MS

MN

NA

NO

CTB

**F4650**

CODICE CODE	FINITURA FINISH	MISURA SIZE		
<b>F4651CHT</b>	Cromo / Chrome	1/2"	1	30
<b>F4652MB</b>	Bronzo spazzolato / Brushed bronze	1/2"	1	30
<b>F4653MA</b>	Acciaio spazzolato / Brushed steel	1/2"	1	30
<b>F4654MR</b>	Rame spazzolato / Brushed copper	1/2"	1	30
<b>F4655MC</b>	Cromo spazzolato / Brushed chrome	1/2"	1	30
<b>F4656MS</b>	Cromo satinato / Satin chrome	1/2"	1	30
<b>F4657MN</b>	Nichel satinato / Satin nickel	1/2"	1	30
<b>F4658NA</b>	Nero antracite / Black anthracite	1/2"	1	30
<b>F4659NO</b>	Nero opaco / Matt black	1/2"	1	30
<b>F4660CTB</b>	Bianco 9010 / White 9010	1/2"	1	30

**F4700**

Valvola versione sinistra termostattabile  
con manopola in ABS

*Valve left version with thermostatic option  
and ABS handle*



CHT

**F4700**

CODICE CODE	FINITURA FINISH	MISURA SIZE		
<b>F4701CHT</b>	Cromo / Chrome	1/2"	1	30

### F4750

Valvola versione sinistra termostattizzabile con cappuccio in ABS bianco  
 Valve left version with thermostatic option and white ABS cup



F4750				
CODICE CODE	FINITURA FINISH	MISURA SIZE		
F4751CHT	Cromo / Chrome	1/2"	1	30
F4752MB	Bronzo spazzolato / Brushed bronze	1/2"	1	30
F4753MA	Acciaio spazzolato / Brushed steel	1/2"	1	30
F4754MR	Rame spazzolato / Brushed copper	1/2"	1	30
F4755MC	Cromo spazzolato / Brushed chrome	1/2"	1	30
F4756MS	Cromo satinato / Satin chrome	1/2"	1	30
F4757MN	Nichel satinato / Satin nickel	1/2"	1	30
F4758NA	Nero antracite / Black anthracite	1/2"	1	30
F4759NO	Nero opaco / Matt black	1/2"	1	30
F4760CTB	Bianco 9010 / White 9010	1/2"	1	30

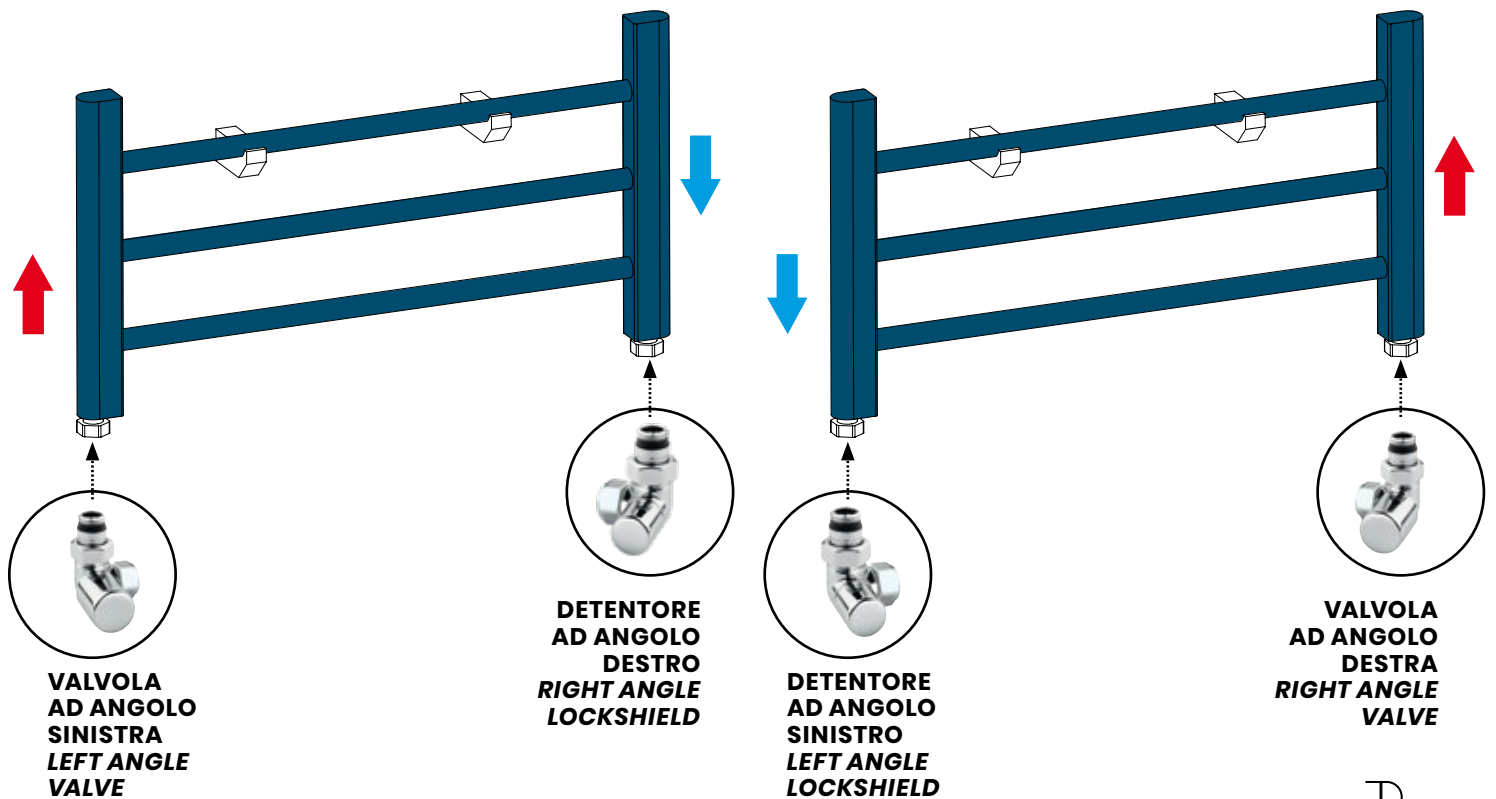
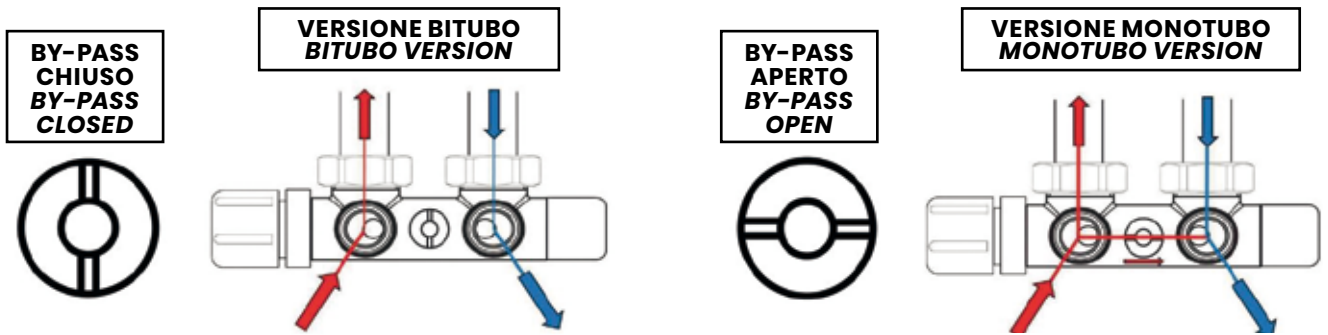
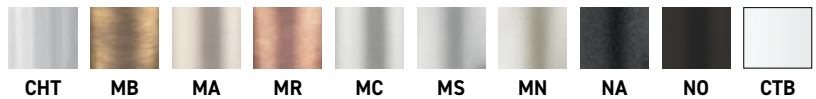

**F5000**

Adattatore a compressione per tubo rame, monocono in gomma, senza calotta 24x19  
*Compression adaptor for copper pipe with rubber monocone, without nut 24x19*





CROMATO   CHROME			
CODICE CODE	MISURA SIZE MM		
F5001R	Ø10	10	100
F5002R	Ø12	10	100
F5003R	Ø14	10	100

**F5100**

Adattatore a compressione per tubo rame, monocono in gomma, senza calotta 24x19  
*Compression adaptor for copper pipe with rubber monocone, without nut 24x19*



CROMATO   CHROME			
CODICE CODE	MISURA SIZE MM		
F5104R	Ø15	10	100
F5105R	Ø16	10	100

**F5200**

Adattatore per tubo plastica, senza calotta 24x19  
*Adaptor for plastic pipe, without nut 24x19*





CROMATO   CHROME			
CODICE CODE	MISURA SIZE MM		
F5201P	Ø12x2	10	100
F5202P	Ø15x2,5	10	100
F5203P	Ø16x2	10	100

**F5300**

Adattatore per tubo multistrato, senza calotta 24x19  
*Adaptor for multilayer pipe, without nut 24x19*





CROMATO   CHROME			
CODICE CODE	MISURA SIZE MM		
F5301M	Ø14x2	10	100
F5302M	Ø15x2,5	10	100
F5303M	Ø16x2	10	100
F5304M	Ø16x2,25	10	100
F5305M	Ø16,2x2,6	10	100
F5306M	Ø16,8x2,5	10	100

**F5600**

Ghiera adattatore per montaggio  
comandi termostatici **SOLO PER**  
**VALVOLE SERIE F3900 - F4250 - F4450**  
Thermostatic head ring nut **ONLY FOR**  
**VALVES ITEM F3900 - F4250 - F4450**



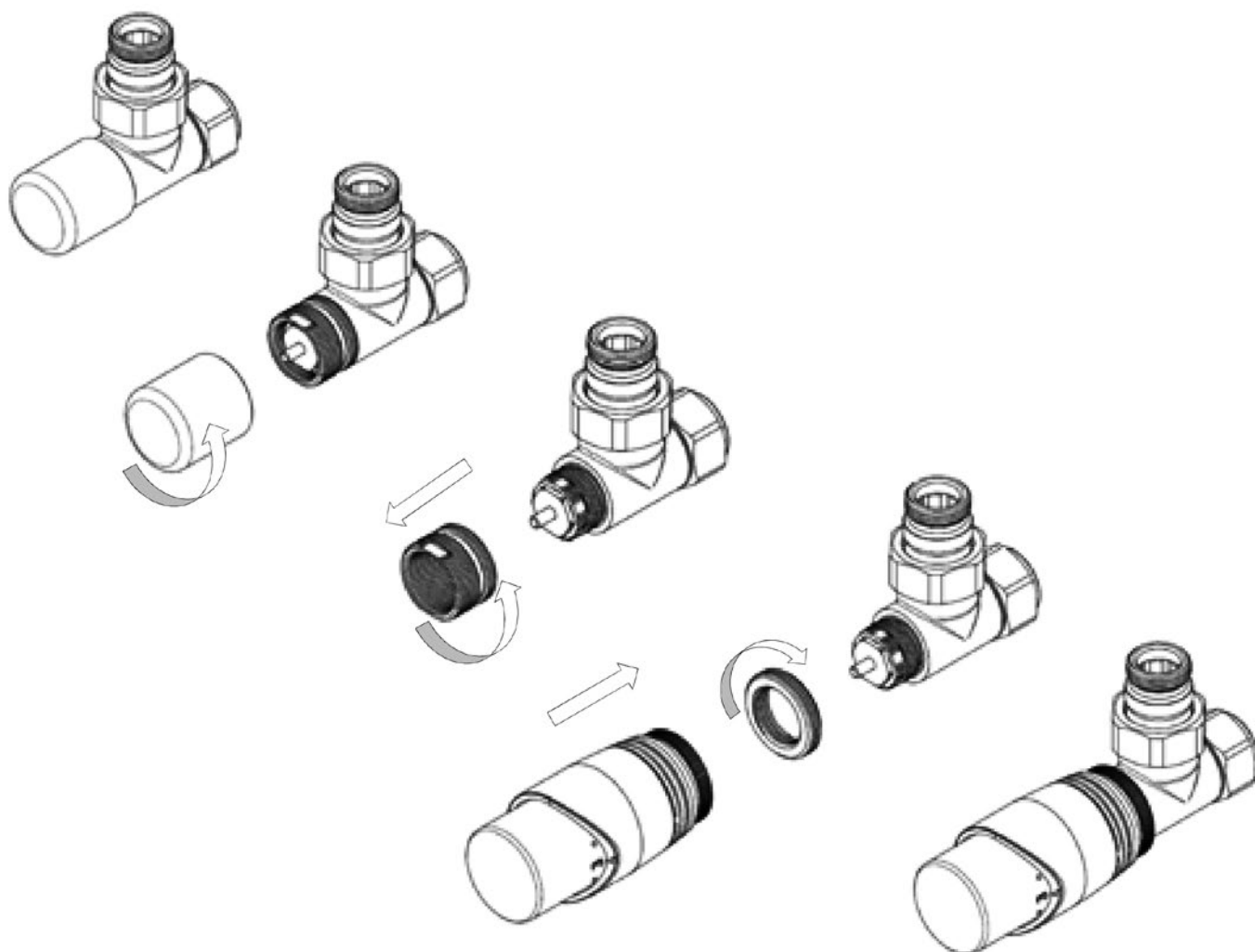

CROMATO   CHROME			
CODICE CODE	MISURA SIZE MM		
F5601HT	30x1,5	1	30



**F6000**

Comando termostatico cromato  
con sensore incorporato  
*Chromium-plated thermostatic head  
with integrated sensor*





F6000				
CODICE CODE	FINITURA FINISH	MISURA SIZE		
<b>F6001LL</b>	Cromo / Chrome	30x1,5	1	30

**F6500**

Comando termostatico bianco  
con sensore incorporato  
*White thermostatic head  
with integrated sensor*





F6500				
CODICE CODE	FINITURA FINISH	MISURA SIZE		
<b>F6501BB</b>	Bianco arredo / White décor	30x1,5	1	30

**F7000**

Comando termostatico nero  
con sensore incorporato  
*Matt black thermostatic head  
with integrated sensor*





F7000				
CODICE CODE	FINITURA FINISH	MISURA SIZE		
<b>F7001NO</b>	Nero opaco / Matt black	30x1,5	1	30

**F5400**

Piastra coprimuro in ottone 2 tubetti  
per tubi  $\varnothing 12 \div \varnothing 16$

Kit for pipes  $\varnothing 12 \div \varnothing 16$  with cover  
and 2 pipes





F5400				
CODICE CODE	FINITURA FINISH	MISURA SIZE		
F5401PHT	Cromo / Chrome	70x $\varnothing$ 18	1	30
F5402PBB	Bianco 9010 / White 9010	70x $\varnothing$ 18	1	30
F5403PMB	Bronzo spazzolato / Brushed bronze	70x $\varnothing$ 18	1	30
F5404PMA	Acciaio spazzolato / Brushed steel	70x $\varnothing$ 18	1	30
F5405PRM	Rame spazzolato / Brushed copper	70x $\varnothing$ 18	1	30
F5406PMC	Cromo spazzolato / Brushed chrome	70x $\varnothing$ 18	1	30
F5407PMS	Cromo satinato / Satin chrome	70x $\varnothing$ 18	1	30
F5408PMN	Nichel satinato / Satin nickel	70x $\varnothing$ 18	1	30
F5409PNA	Nero antracite / Black anthracite	70x $\varnothing$ 18	1	30
F5410PNO	Nero opaco / Matt black	70x $\varnothing$ 18	1	30

**F5450**

Kit coprimuro in ottone 2 rosoni  $\varnothing 55$   
e 2 tubetti per tubi  $\varnothing 12 \div \varnothing 16$

Kit for pipes  $\varnothing 12 \div \varnothing 16$  with 2 wall covers  
 $\varnothing 55$  and 2 pipes



F5450				
CODICE CODE	FINITURA FINISH	MISURA SIZE		
F5451OHT	Cromo / Chrome	70x $\varnothing$ 18	1	30
F5452OBB	Bianco 9010 / White 9010	70x $\varnothing$ 18	1	30
F5453OMB	Bronzo spazzolato / Brushed bronze	70x $\varnothing$ 18	1	30
F5454OMA	Acciaio spazzolato / Brushed steel	70x $\varnothing$ 18	1	30
F5455OMR	Rame spazzolato / Brushed copper	70x $\varnothing$ 18	1	30
F5456OMC	Cromo spazzolato / Brushed chrome	70x $\varnothing$ 18	1	30
F5457OMS	Cromo satinato / Satin chrome	70x $\varnothing$ 18	1	30
F5458OMN	Nichel satinato / Satin nickel	70x $\varnothing$ 18	1	30
F5459ONA	Nero antracite / Black anthracite	70x $\varnothing$ 18	1	30
F5460ONO	Nero opaco / Matt black	70x $\varnothing$ 18	1	30





CANNE E TUBI  
CONNECTIONS AND PIPES



FP PATTARONI



MADE IN ITALY

**CANNE E TUBI  
CONNECTIONS  
AND PIPES**

**F506**

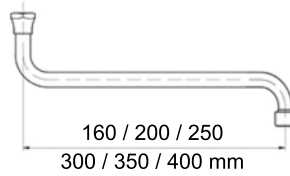
Canne per lavello "S" con rompigitto e ghiera  
*"S" spout for sink with jet-breaker brass and hexagonal cap*



**CROMATO LUCIDO | CHROME-PLATED**

CODICE CODE	MISURA SIZE MM		
F506CR001	3/4" L=160	10	-
F506CR002	3/4" L=200	10	-
F506CR003	3/4" L=250	10	-
F506CR004	3/4" L=300	10	-
F506CR005	3/4" L=350	10	-
F506CR006	3/4" L=400	10	-

**F507**

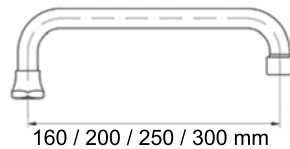
Canne per lavello "U" con rompigitto e ghiera  
*"U" spout for sink with jet-breaker brass and hexagonal cap*



**CROMATO LUCIDO | CHROME-PLATED**

CODICE CODE	MISURA SIZE MM		
F507CR001	3/4" L=160	10	-
F507CR002	3/4" L=200	10	-
F507CR003	3/4" L=250	10	-
F507CR004	3/4" L=300	10	-

**F508**

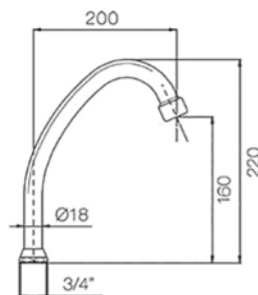
Canne per monoforo universale con rompigitto  
 e ghiera  
*Universal spout for single hole with jet-breaker  
 brass and hexagonal cap*



**CROMATO LUCIDO | CHROME-PLATED**

CODICE CODE	MISURA SIZE MM		
F508CR001	3/4" L=200	10	-
F508CR002	3/4" L=150	10	-

**F509**

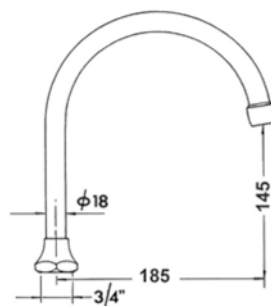
Canne a ponte attacco 3/4" con rompigitto e ghiera  
*Bridge shaped spout for sink with jet-breaker brass  
 and hexagonal cap*

**CROMATO LUCIDO | CHROME-PLATED**



CODICE CODE	MISURA SIZE MM		
F509CR001	3/4" L=185	10	-

**F986**

Rotolo in rame 5 mt.  
Copper roll 5 mt.



## CROMATO LUCIDO | CHROME-PLATED



CODICE CODE	MISURA SIZE		
<b>F986CR001</b>	Ø10	1	10
<b>F986CR002</b>	Ø12	1	10
<b>F986CR003</b>	Ø14	1	8

**F164**

Sonda in rame  
Chromed copper tube chromed



## CROMATO LUCIDO | CHROME-PLATED



CODICE CODE	MISURA SIZE MM		
<b>F164CR001</b>	10x1000	10	-
<b>F164CR002</b>	12x1000	10	-
<b>F164CR003</b>	14x1000	10	-

**F321**

Tubo con bicono  
Copper tube with nut



## CROMATO LUCIDO | CHROME-PLATED



CODICE CODE	MISURA SIZE MM		
<b>F321CR001</b>	Ø10x300	10	-
<b>F321CR002</b>	Ø10x400	10	-

**F163**

Tubo per riscaldamento cromato

*Copper tube for heating system chrome plated*

## CROMATO LUCIDO | CHROME-PLATED



CODICE CODE	MISURA SIZE MM		
<b>F163CR003</b>	Ø14x150-1/2"	10	-

**F318**

Tubo con cartella

*Copper tube with fold*

## CROMATO LUCIDO | CHROME-PLATED



CODICE CODE	MISURA SIZE MM		
<b>F318CR009</b>	1/2"x300x10	25	-
<b>F318CR010</b>	1/2"x350x10	25	-
<b>F318CR011</b>	1/2"x400x10	25	-
<b>F318CR012</b>	1/2"x500x10	25	-
<b>F318CR014</b>	1/2"x1000x10	25	-

**F240**

Canotto con cartella maggiorata

*Brass tube with increased fold chrome plated*





## CROMATO LUCIDO | CHROME-PLATED

CODICE CODE	MISURA SIZE MM		
<b>F240CR002</b>	Ø26x250 x1"1/4	10	-
<b>F240CR003</b>	Ø26x300 x1"1/4	10	-

**F236**

Canotto per sifone  
Brass tube for siphon







CROMATO LUCIDO   CHROME-PLATED				CROMATO LUCIDO   CHROME-PLATED			
CODICE CODE	MISURA SIZE MM			CODICE CODE	MISURA SIZE MM		
F236CR001	Ø24x200	10	-	F236CR015	Ø30x300	10	-
F236CR002	Ø24x250	10	-	F236CR016	Ø30x1000	10	-
F236CR003	Ø24x300	10	-	F236CR017	Ø32x200	10	-
F236CR004	Ø24x1000	10	-	F236CR018	Ø32x250	10	-
F236CR005	Ø25x200	10	-	F236CR019	Ø32x300	10	-
F236CR006	Ø25x250	10	-	F236CR020	Ø32x1000	10	-
F236CR007	Ø25x300	10	-	F236CR021	Ø35x200	10	-
F236CR008	Ø25x1000	10	-	F236CR022	Ø35x250	10	-
F236CR009	Ø26x200	10	-	F236CR023	Ø35x300	10	-
F236CR010	Ø26x250	10	-	F236CR024	Ø35x1000	10	-
F236CR011	Ø26x300	10	-	F236CR025	Ø40x200	10	-
F236CR012	Ø26x1000	10	-	F236CR026	Ø40x250	10	-
F236CR013	Ø30x200	10	-	F236CR027	Ø40x300	10	-
F236CR014	Ø30x250	10	-	F236CR028	Ø40x1000	10	-

**F413**

Canotto con cartella  
Brass tube with fold chrome plated





CROMATO LUCIDO   CHROME-PLATED				CROMATO LUCIDO   CHROME-PLATED			
CODICE CODE	MISURA SIZE MM			CODICE CODE	MISURA SIZE MM		
F413CR001	Ø24x200	10	-	F413CR010	Ø30x200	10	-
F413CR002	Ø24x250	10	-	F413CR011	Ø30x250	10	-
F413CR003	Ø24x300	10	-	F413CR012	Ø30x300	10	-
F413CR004	Ø25x200	10	-	F413CR013	Ø32x200	10	-
F413CR005	Ø25x250	10	-	F413CR014	Ø32x250	10	-
F413CR006	Ø25x300	10	-	F413CR015	Ø32x300	10	-
F413CR007	Ø26x200	10	-	F413CR019	Ø40x200	10	-
F413CR008	Ø26x250	10	-	F413CR020	Ø40x250	10	-
F413CR009	Ø26x300	10	-	F413CR021	Ø40x300	10	-

**F305**

Canotto rigato flessibile  
Flexible striped brass tube





CROMATO LUCIDO   CHROME-PLATED			
CODICE CODE	MISURA SIZE MM		
F305CR003	Ø26x300	10	-
F305CR008	Ø30x300	10	-
F305CR012	Ø32x250	10	-
F305CR013	Ø32x300	10	-
F305CR014	Ø32x400	10	-

**F425**

Canotto telescopico con OR in gomma  
Adjustable brass tube with rubber OR



## CROMATO LUCIDO | CHROME-PLATED



CODICE CODE	MISURA SIZE MM		
<b>F425CR001</b>	Ø26 x regolaz. 40	10	-
<b>F425CR002</b>	Ø30 x regolaz. 40	10	-
<b>F425CR003</b>	Ø32 x regolaz. 40	10	-

**F426**

Giunzione ridotta con 2 OR in gomma  
Reduced brass junction with 2 rubber OR



## CROMATO LUCIDO | CHROME-PLATED



CODICE CODE	MISURA SIZE MM		
<b>F426CR001</b>	Ø26x32	10	-
<b>F426CR002</b>	Ø32x40	10	-

**F427**

Giunzione con 2 OR in gomma  
Brass junction with 2 rubber OR



## CROMATO LUCIDO | CHROME-PLATED



CODICE CODE	MISURA SIZE MM		
<b>F427CR001</b>	Ø26x26 mm	10	-
<b>F427CR002</b>	Ø30x30 mm	10	-
<b>F427CR003</b>	Ø32x32 mm	10	-
<b>F427CR004</b>	Ø40x40 mm	10	-

**F428**



Manicotto ridotto a saldare con OR  
Reduced socket with OR



## GIALLO | YELLOW

CODICE CODE	MISURA SIZE		
<b>F428R001</b>	Ø26x32	10	-
<b>F428R002</b>	Ø32x40	10	-



## CROMATO LUCIDO | CHROME-PLATED

CODICE CODE	MISURA SIZE MM		
<b>F428CR001</b>	Ø26x32	10	-
<b>F428CR002</b>	Ø32x40	10	-

**F108**

Attacco flessibile per lavatrici in ABS  
*ABS flexible attach for washing machine*



ABS   ABS			
CODICE CODE	MISURA SIZE		
F108CR001	1"	10	

**F2150**

Tubo scarico lavatrice estensibile  
*Extensible drain tube for washing-machine*





PLASTICA   PLASTIC			
CODICE CODE	MISURA SIZE		
F2150CR001	80-120 cm	10	-

**F2002**

Sistema magnetico anticalcare MF  
*Anti-limescale device with permanent magnet MF*



GIALLO   YELLOW			
CODICE CODE	MISURA SIZE		
F2002CR001	1/2"MF	1 (#)	50
F2002CR002	3/4"MF	1 (#)	50

(#) confezione blister / *packaging blister*

DATI TECNICI   TECHNICAL DATA		
PRESSIONE MAX MAX. PRESSURE	TEMPERATURA MAX MAX. TEMPERATURE	PORTATA FLOW RATE
20 bar	100° C/ x lavatrice	18 Lt/min
20 bar	100° C/ x lavatrice	18 Lt/min







FP PATTARONI

MADE IN ITALY

**CURVETTE  
E RUBINETTI  
ELBOWS  
AND TAPS**





CURVETTE E RUBINETTI  
ELBOES AND TAPS

**F040**

Curvetta attacco doccia con rosone MM  
sede piana  
*Male elbow with rosette*



## CROMATO LUCIDO | CHROME-PLATED



CODICE CODE	MISURA SIZE		
Rosone ottone / Brass rosette <b>F040CR001</b>	1/2"x1/2"	10	50
Rosone inox / Innox rosette <b>F040CR002</b>	1/2"x1/2"	10	50
Solo curvetta / Only elbow <b>F040CR003</b>	1/2"x1/2"	10	50

**F041**

Curvetta scaldabagno cromata  
*Chrome plated boiler elbow*



## CROMATO LUCIDO | CHROME-PLATED



CODICE CODE	MISURA SIZE		
<b>F041CR001</b>	1/2"Fx1/2"M	10	100
<b>F041CR002</b>	3/4"Fx1/2"M	10	100

**F71**

Curvetta sottolavabo fissa  
*Fixed elbow for wash basin*



## CROMATO LUCIDO | CHROME-PLATED

CODICE CODE	MISURA SIZE		
<b>F71CR002</b>	1/2"x10 mm	2	50
<b>F71CR003</b>	1/2"x3/8" (#)	2	50



(#) senza calotta / without cap

**F72**

Curva completa di calotta e rosone  
per art. F142  
*Elbow with nut and flange for art. F142*



## CROMATO LUCIDO | CHROME-PLATED



CODICE CODE	MISURA SIZE		
<b>F72CR001</b>	1/2"x3/4"	10	150

**F7**

Curvetta sottolavabo stampata  
*Stamped elbow for wash basin*



CROMATO LUCIDO | CHROME-PLATED



CODICE CODE	MISURA SIZE		
<b>F7CR002</b>	1/2" - Ø10 - 90°	2	100

**F2**

Rubinetto sottolavabo con snodo a sfera  
*Angle valve stop-cock with ball joint*



CROMATO LUCIDO | CHROME-PLATED

CODICE CODE	MISURA SIZE MM		
<b>F2CR001</b>	1/2"x10	1	50

**F044**

Rubinetto sottolavabo a sfera  
*Angle valve stop cock*



CROMATO LUCIDO | CHROME-PLATED



CODICE CODE	MISURA SIZE		
<b>F044CR001</b>	1/2"x3/8"	1	50

**F045**

Rubinetto sottolavabo con chiusura a vitone  
*Angle valve for wash basin, with swivel*



CROMATO LUCIDO | CHROME-PLATED

CODICE CODE	MISURA SIZE		
<b>F045CR001</b>	1/2"x3/8" - Ø10	1	50
<b>F045CR003</b>	1/2"x3/8" (#)	1	50



(#) senza calotta - *without cap*

**F1**

Rubinetto per cassetta WC con tubetto rame  
*Angle valve for water box with copper tube*



CROMATO LUCIDO | CHROME-PLATED



CODICE CODE	MISURA SIZE		
<b>F1CR001</b>	1/2"x3/8" - Ø10	1	50

**F47**

Rubinetto sottolavabo con filtro e chiusura a vite  
*Angle-valve for wash basin with filter and swivel*



CROMATO LUCIDO | CHROME-PLATED

CODICE CODE	MISURA SIZE MM		
<b>F47CR003</b>	1/2"x10	2	50

**F094**

Rubinetto combinato senza filtro ispezionabile  
*Combined tap without inspection filter*



CROMATO LUCIDO | CHROME-PLATED

CODICE CODE	MISURA SIZE MM		
<b>F094CR001</b>	#	1	50

(#) senza filtro - *without filter*

**F095**

Rubinetto combinato con filtro ispezionabile  
*Combined tap with inspection filter*



CROMATO LUCIDO | CHROME-PLATED

CODICE CODE	MISURA SIZE MM		
<b>F095CR001</b>	#	1	50



(#) con filtro - *with filter*

**F780**

Rubinetto lavatrice  
Tap for washing machine



CROMATO LUCIDO | CHROME-PLATED

CODICE CODE	MISURA SIZE		
F780CR001	3/8"x3/4"	10	100
F780CR002	1/2"x3/4"	10	100

**F782**

Rubinetto 3 vie economico  
Three ways economical tap



CROMATO LUCIDO | CHROME-PLATED



CODICE CODE	MISURA SIZE MM		
F782CR002	1/2"x3/4"	10	100

**F142**

Rubinetto per contatori acqua  
Water meter tap



CROMATO LUCIDO | CHROME-PLATED

CODICE CODE	MISURA SIZE MM		
F142CR001	1/2"x3/4"	5	-

**F613**

Rubinetto a snodo con canna  
Sink tap with swinging spout



CROMATO LUCIDO | CHROME-PLATED

CODICE CODE	MISURA SIZE		
F613CR001	1/2"	1	5



**F0147**

Rubinetto artistico a sfera passo rapido 1/2" M  
*Artistic tap 1/2" M, ball cartridge*



GIALLO | YELLOW



CODICE CODE	MISURA SIZE		
<b>F0147R001</b>	1/2"	1	10

**F0119**

Rubinetto artistico con vitone passo rapido 1/2" M  
*Artistic tap 1/2" M, screw cartridge*



GIALLO | YELLOW

CODICE CODE	MISURA SIZE		
<b>F0119R001</b>	1/2"	1	10

**F0266**

Rubinetto classico con vitone tradizionale a premistoppa e portasecchiello da 1/2" M  
*Tap with traditional screw with stuffing 1/2" M*



GIALLO | YELLOW

CODICE CODE	MISURA SIZE		
<b>F0266R001</b>	1/2"	1	10

**F380**

Rubinetto a pulsante per fontane  
Push button tap for fountains



GIALLO LUCIDO   POLISHED YELLOW			
CODICE CODE	MISURA SIZE MM		
F380GL001	1/2"	5	-

CROMATO LUCIDO   CHROME-PLATED			
CODICE CODE	MISURA SIZE MM		
F380CR001	1/2"	5	-

**F382**

Rubinetto portagomma  
Hose union bib cock



GIALLO SABBATO   SUNBLASTED YELLOW			
CODICE CODE	MISURA SIZE		
F382GS005	1/2"	10	-
F382GS009	3/4"	10	-

GIALLO LUCIDO   POLISHED YELLOW			
CODICE CODE	MISURA SIZE		
F382GL006	1/2"	10	-
F382GL010	3/4"	10	-

**F620**

Rubinetto portagomma a sfera  
Ball hose union bib cock



CROMATO LUCIDO   CHROME-PLATED			
CODICE CODE	MISURA SIZE MM		
F620CR002B	1/2"	20	-
F620CR002R	1/2"	20	-
F620CR003B	3/4"	15	-
F620CR003R	3/4"	15	-
F620CR004B	1"	10	-
F620CR004R	1"	10	-

(B) leva blu - blue handle / (R) leva rossa - red handle

**F621**

Codolo e girello  
Brass shank and tap union



CROMATO   CHROME			
CODICE CODE	MISURA SIZE		
F621CR001	3/4"X1/2"	25	-
F621CR002	1"X3/4"	25	-
F621CR003	1"1/4X1"	25	-





FP PATTARONI

MADE IN ITALY

VALVOLE  
VALVES

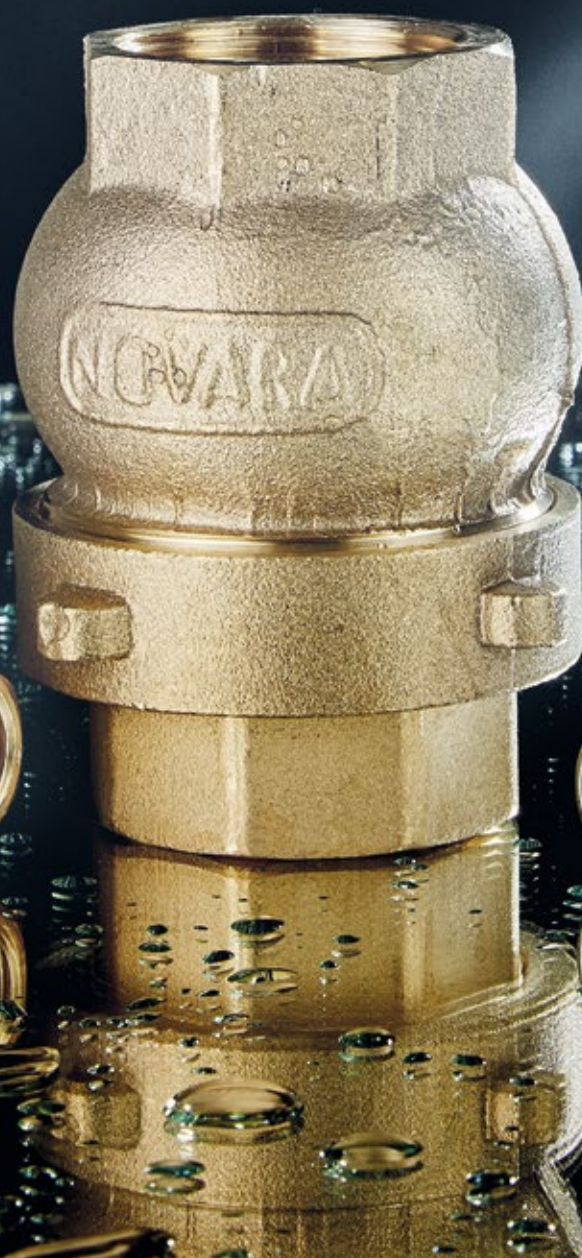



VALVOLE  
VALVES

**F254**

Valvola sfera mini MF  
Mini ball valve MF





CROMATO   CHROME			
CODICE CODE	MISURA SIZE		
F254CR000	1/4" Mx 1/4" F	50	200
F254CR001	3/8" Mx 3/8" F	50	200
F254CR002	1/2" Mx 1/2" F	50	200
F254CR004	3/4" Mx 3/4" F	25	50

**F250**

Valvola sfera mini FF  
Mini ball valve FF





CROMATO   CHROME			
CODICE CODE	MISURA SIZE		
F250CR000	1/4" Fx 1/4" F	50	200
F250CR001	3/8" Fx 3/8" F	50	200
F250CR002	1/2" Fx 1/2" F	50	200

**F608**

Valvola sfera scarico caldaia  
Ball valve for boiler drain





CROMATO   CHROME			
CODICE CODE	MISURA SIZE		
F608CR002	1/2" x 3/4"	10	100

**F607**

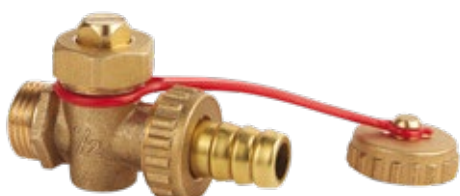
Rubinetto scarico caldaia taglio  
cacciavite  
Boiler drain with screwdriver cut





GIALLO   YELLOW			
CODICE CODE	MISURA SIZE		
F607R001	1/2" x 3/4"	10	100

**F5**

Valvola di ritegno FF, con otturatore  
in Teflon

*Non-return check valve FF  
Teflon shutter*





GIALLO   YELLOW			
CODICE CODE	MISURA SIZE		
F5R003	1/2"	10	-
F5R004	3/4"	10	-
F5R005	1"	10	-
F5R006	1"1/4	10	-
F5R007	1"1/2	5	-
F5R008	2"	5	-
F5R009	2"1/2	1	-
F5R010	3"	1	-
F5R011	4"	1	-

**F5K**

Valvola di ritegno FF, con otturatore  
in metallo

*Non-return check valve FF  
metal shutter*





GIALLO   YELLOW			
CODICE CODE	MISURA SIZE		
F5KR002	1/2"	10	-
F5KR003	3/4"	10	-
F5KR004	1"	10	-
F5KR005	1"1/4	10	-
F5KR006	1"1/2	5	-
F5KR007	2"	5	-
F5KR008	2"1/2	1	-
F5KR009	3"	1	-
F5KR010	4"	1	-

**F4**

Valvola a clapet tenuta gomma  
*Brass swing check valve*





GIALLO   YELLOW			
CODICE CODE	MISURA SIZE		
F4R002	1/2"	10	-
F4R003	3/4"	10	-
F4R004	1"	10	-
F4R005	1"1/4	10	-
F4R006	1"1/2	5	-
F4R007	2"	5	-
F4R008	2"1/2	1	-
F4R009	3"	1	-
F4R010	4"	1	-

**F46**

Valvola pozzo tipo Novara FF  
Well valve Novara type FF



## GIALLO | YELLOW



CODICE CODE	MISURA SIZE		
<b>F46R001</b>	1"	10	-
<b>F46R002</b>	1"1/4	10	-
<b>F46R003</b>	1"1/2	10	-

**F2152**

Guarnizione in gomma nera per il vitone dell'art. F46  
Black gasket for headwork of art. F46



## GOMMA | RUBBER



CODICE CODE	MISURA SIZE		
<b>F2152CR000</b>	Ø40 x vit. da 1"	20	-
<b>F2152CR001</b>	Ø45 x vit. da 1"1/4	20	-
<b>F2152CR002</b>	Ø50 x vit. da 1"1/2	20	-

**F3**

Filtro inox con raccordo in nylon  
Stainless steel filter with plastic fitting



## CROMATO | CHROME



CODICE CODE	MISURA SIZE		
<b>F3R003</b>	1/2"	10	-
<b>F3R004</b>	3/4"	10	-
<b>F3R005</b>	1"	10	-
<b>F3R006</b>	1"1/4	10	-
<b>F3R007</b>	1"1/2	5	-
<b>F3R008</b>	2"	5	-

**F65**

Valvolina scarico aria  
Air-vent valve





## CROMATO LUCIDO | CHROME-PLATED

CODICE CODE	MISURA SIZE		
<b>F65CR000</b>	1/4"	50	400
<b>F65CR001</b>	3/8"	50	400
<b>F65CR003</b>	1/2"	50	300

**F204**

Saracinesca attacco FF PN16  
Brass gate valve FF PN16





GIALLO   YELLOW			
CODICE CODE	MISURA SIZE		
F204R003	1/2"	20	-
F204R004	3/4"	10	-
F204R005	1"	10	-
F204R006	1"1/4"	10	-
F204R007	1"1/2"	5	-
F204R008	2"	5	-
F204R009	2"1/2"	1	-
F204R010	3"	1	-
F204R011	4"	1	-
F204R012	5"	1	-
F204R013	6"	1	-

**F579**

Idrante a squadra per giardino  
con portagomma  
Square hydrant with hose union  
for garden





GIALLO   YELLOW			
CODICE CODE	MISURA SIZE		
F579R001	1/2"	10	100
F579R002	3/4"	10	70

**F419**

Valvola inclinata in ottone a via  
diretta con molla di ritorno  
Inclined brass valve  
with contrast spring





GIALLO   YELLOW			
CODICE CODE	MISURA SIZE		
F419R003	1/2"	10	-
F419R004	3/4"	10	-
F419R005	1"	10	-
F419R006	1"1/4"	10	-
F419R007	1"1/2"	10	-
F419R008	2"	10	-

**F418**

Rubinetto di spurgo in ottone  
Brass drain-cock





GIALLO   YELLOW			
CODICE CODE	MISURA SIZE		
F418R001	1/4"	10	300

**F45**

Valvola di fondo tubolare  
*Cylindrical brass foot valve*



## GIALLO | YELLOW



CODICE CODE	MISURA SIZE		
F45R002	3/4"	10	-
F45R003	1"	10	-
F45R004	1"1/4	5	-
F45R005	1"1/2	5	-
F45R006	2"	1	-
F45R008	3"	1	-

**F602**

Giunto di dilatazione telescopico  
in ottone  
*Telescopic brass extension joint*



## GIALLO | YELLOW



CODICE CODE	MISURA SIZE		
F602R001	1/2"	5	-
F602R002	3/4"	5	-
F602R003	1"	5	-
F602R004	1"1/4	1	-
F602R005	1"1/2	1	-
F602R006	2"	1	-

**F415**

Raccoglitore di impurità a Y in ottone  
*Brass "Y" pattern filter*



## GIALLO | YELLOW



CODICE CODE	MISURA SIZE		
F415R001	3/8"	10	-
F415R002	1/2"	10	-
F415R003	3/4"	10	-
F415R004	1"	10	-
F415R005	1"1/4	5	-
F415R006	1"1/2	5	-
F415R007	2"	5	-
F415R008	2"1/2	1	-
F415R009	3"	1	-

**F2151**

Guarnizione rossa in gomma per  
valvole F45  
*Red rubber gasket for F45 valves*



## GOMMA | RUBBER

CODICE CODE	MISURA SIZE		
F2151CR000	Ø23 - 3/4"	10	-
F2151CR001	Ø26 - 1"	10	-
F2151CR002	Ø32 - 1"1/4	10	-
F2151CR003	Ø40 - 1"1/2	10	-
F2151CR004	Ø45 - 2"	10	-
F2151CR005	Ø50 - 3"	10	-



FP PATTARONI

MADE IN ITALY

**ROSONI  
ED ECCENTRICI  
ROSETTES  
AND ECCENTRICS**



### F179

Eccentrico per radiatori  
*Eccentric for radiator*

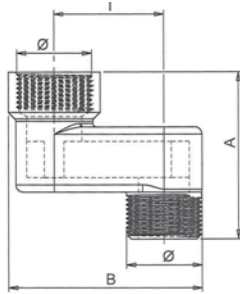
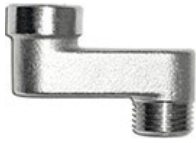

CROMATO   CHROME						
CODICE CODE	MISURA SIZE MM	I	A	B		
F179CR001	3/8"x10	10	43	34	10	-
F179CR002	3/8"x20	20	46	43	10	-
F179CR003	3/8"x30	30	46	53	10	-
F179CR004	3/8"x40	40	46	63	10	-
F179CR005	3/8"x50	50	45	73	10	-
F179CR006	3/8"x60	60	44	83	10	-
F179CR007	1/2"x10	10	43	34	10	-
F179CR008	1/2"x20	20	46	43	10	-
F179CR009	1/2"x30	30	46	53	10	-
F179CR010	1/2"x40	40	46	63	10	-
F179CR011	1/2"x50	50	45	73	10	-
F179CR012	1/2"x60	60	44	83	10	-

### F178

Eccentrico per termoarredo cromato lucido  
*Chrome polished eccentric*

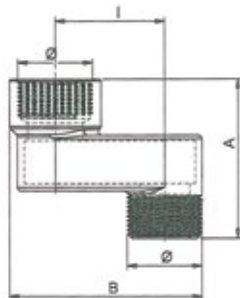

CROMATO   CHROME						
CODICE CODE	MISURA SIZE MM	I	A	B		
F178CR007	1/2"x10	10	44	33	10	-
F178CR008	1/2"x20	20	44	43	10	-
F178CR009	1/2"x30	30	44	53	10	-

### F24

Eccentrico retrogruppo  
*Eccentric rear group*

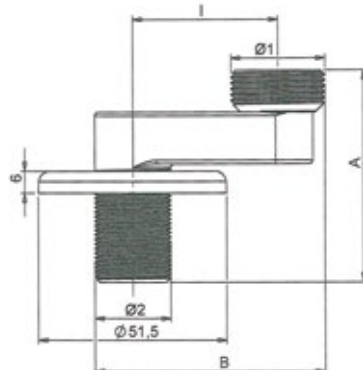

CROMATO   CHROME						
CODICE CODE	MISURA SIZE	I	A	B		
F24CR001	4 cm	40	58,5	63	10	50
F24CR002	6 cm	60	58,5	83	10	40
F24CR003	8 cm	80	58,5	103	10	40
F24CR004	10 cm	100	58,5	123	10	30

**F216**

Rosone con gambo eccentrico interasse mm. 10  
*Rosette with eccentric shank 10 mm. wheel base*

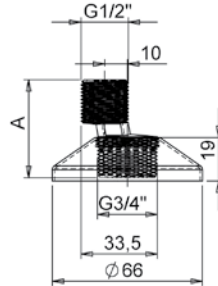

CROMATO | CHROME

CODICE CODE	MISURA SIZE MM	I	A	B		
F216CR001	3/4"x1/2"	10	43	33,5	10	-
F216CR002	3/4"x1/2"	10	50	33,5	10	-

**F217**

Rosone con gambo eccentrico interasse mm. 25  
*Rosette with eccentric shank 25 mm. wheel base*

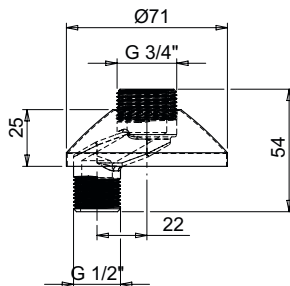

CROMATO | CHROME

CODICE CODE	MISURA SIZE		
F217CR001	1/2"x3/4"	10	-

**ISL001**

Valvola sfera eccentrica 10 mm con comando a cacciavite in ottone DRZ  
*10 mm eccentric-ball valve with screwdriver cut in DRZ brass*



CROMATO LUCIDO | CHROME-PLATED

CODICE CODE	MISURA SIZE		
ISL001CR002			





FP PATTARONI

MADE IN ITALY



**VARIE  
VARIOUS**



### F8

Rompigetto  
*Jet-breaker*



CROMATO LUCIDO   CHROME-PLATED			
CODICE CODE	MISURA SIZE		
<b>F8CR002</b>	24x1"M	10	500

### F9

Aeratore  
*Aerator*





CROMATO LUCIDO   CHROME-PLATED			
CODICE CODE	MISURA SIZE		
<b>F9CR001</b>	22x1"F	10	500
<b>F9CR002</b>	24x1"M	10	500
<b>F9CR003</b>	28x1"M	10	300

### F80

Aeratore con snodo a doppio  
getto a risparmio idrico  
*Aerator with double jet water  
saving joint*





CROMATO LUCIDO   CHROME-PLATED			
CODICE CODE	MISURA SIZE		
<b>F80CR001</b>	22x1"F		
<b>F80CR002</b>	24x1"M		



### F10

Tappo saltarello  
*Brass cover plate*





CROMATO   CHROME			
CODICE CODE	MISURA SIZE		
<b>F10CR001</b>	1"	10	40
<b>F10CR002</b>	1"1/4	10	40

### F11

Tappo copriforo  
Brass cover plate



CROMATO   CHROME			
CODICE CODE	MISURA SIZE		
F11CR001	-	1	50

### F604

Piletta di scarico automatica  
Trap with automatic pop-up waste





CROMATO   CHROME			
CODICE CODE	MISURA SIZE		
F604CR001	1"	5	-
F604CR002	1"1/4	5	-

### F605

Piletta di scarico con troppo pieno  
con chiusura a scatto  
Click-clack trap with over flow pipe





CROMATO LUCIDO   CHROME-PLATED			
CODICE CODE	MISURA SIZE		
F605CR001	1"1/4	5	20

### F606

Piletta di scarico senza troppo pieno  
con chiusura a scatto  
Click-clack trap without over flow pipe



CROMATO LUCIDO   CHROME-PLATED			
CODICE CODE	MISURA SIZE		
F606CR001	1"1/4	5	20

**F050CL**

Piletta di scarico per lavabo in cristallo  
*Trap with pop-up waste for crystal basin*





CROMATO   CHROME			
CODICE CODE	MISURA SIZE		
F050CL001	1"1/4	10	20
F050CL002	1"1/4	10	-
F050CL003	1"1/4	10	-
F050CL004	1"1/4	10	-
F050CL005	1"1/4	10	-

- \_\_001 piletta lavabo click clap regolabile - cromo  
*click clap adjustable washbasin drain - chrome*
- \_\_002 cover tonda in ottone nichel lucido spazzolato  
*round cover in polished nickel brushed brass*
- \_\_003 cover tonda in acciaio inox 304 spazzolata  
*round cover in stainless steel 304 brushed*
- \_\_004 cover tonda in ceramica bianca lucida - in ottone  
*round cover in polished white ceramic - in brass*
- \_\_005 cover tonda in ceramica bianca lucida - in acciaio inox 304  
*round cover in polished white ceramic - in stainless steel 304*

**F100KIT**

KIT Passo rapido universale  
*Universal tap kit*





CROMATO   CHROME			
CODICE CODE	MISURA SIZE		
F100KIT001	-	1	30

**F101KIT**

KIT Vitoni universali  
*Universal headwork kit*





GIALLO   YELLOW			
CODICE CODE	MISURA SIZE		
F101KIT001	-	1	60

### F104

Maniglia freddo/caldo  
Handle hot/cold



#### CROMATO LUCIDO | CHROME-PLATED



CODICE CODE			
F104CR001	BLU/BLUE	10	-
F104CR002	ROSSO/RED	10	-

### F98

Passo rapido per WC incasso  
Internal tap for WC



#### CROMATO LUCIDO | CHROME-PLATED



CODICE CODE	MISURA SIZE		
F98CR001	3/4"	1	-
F98CR002	1"	1	-

### F97

Passo rapido per WC esterno  
External tap for WC



#### CROMATO LUCIDO | CHROME-PLATED

CODICE CODE	MISURA SIZE		
F97CR001	3/4"	1	-
F97CR002	1"	1	-
F97CR003*	1"	1	-



\* con molla di ritorno - with return spring

### F54CR

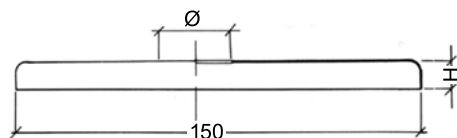
Piastra rettangolare per passo rapido incasso  
Rectangular quick-pitch plate



#### CROMATO LUCIDO | CHROME-PLATED

CODICE CODE	MISURA SIZE MM		
F54CR001	Ø25 - H=5	5	-
F54CR002	Ø25 - H=10	5	-
F54CR004	Ø28 - H=5	5	-



**F807**

Codolo per ricambistica F18 e F19  
sede conica

*Tang for spare parts F18 and F19,  
conical seat*



## GIALLO | YELLOW

CODICE CODE	MISURA SIZE		
<b>F807R001</b>	1/2"	1	-
<b>F807R002</b>	3/4"	1	-
<b>F807R003</b>	1"	1	-
<b>F807R004</b>	1"1/4	1	-
<b>F807R005</b>	1"1/2	1	-
<b>F807R006</b>	2"	1	-



**F808**

Codolo per ricambistica F803, F802  
e F622 sede piana

*Tang for spare parts F803, F802  
and F622, flat seat*



## GIALLO | YELLOW

CODICE CODE	MISURA SIZE		
<b>F808R001</b>	1/2"	1	-
<b>F808R002</b>	3/4"	1	-
<b>F808R003</b>	1"	1	-
<b>F808R004</b>	1"1/4	1	-
<b>F808R005</b>	1"1/2	1	-
<b>F808R006</b>	2"	1	-



**F809**

Calotta per ricambistica F18, F19,  
F803, F802 e F622

*Cap for spare parts F18, F19, F803,  
F802 and F622*



## GIALLO | YELLOW

CODICE CODE	MISURA SIZE		
<b>F809R001</b>	3/4"	1	-
<b>F809R002</b>	1"	1	-
<b>F809R003</b>	1"1/4	1	-
<b>F809R004</b>	1"1/2	1	-
<b>F809R005</b>	2"	1	-
<b>F809R006</b>	2"1/2	1	-

CERTIFICAT

CERTIFICADO

СЕРТИФИКАТ

初 證 證 書

CERTIFICATE

ZERTIFIKAT



Italia

# CERTIFICATO

Nr. 50 100 16568 Rev.001

SI ATTESTA CHE / THIS IS TO CERTIFY THAT

IL SISTEMA DI GESTIONE PER LA QUALITÀ DI  
THE QUALITY MANAGEMENT SYSTEM OF



**FP PATTARONI S.r.l.**

SEDE LEGALE E OPERATIVA:  
REGISTERED OFFICE AND OPERATIONAL SITE:

**VIA DEI CASTAGNI 3  
IT - 28017 SAN MAURIZIO D'OPAGLIO (NO)**

È CONFORME AI REQUISITI DELLA NORMA  
HAS BEEN FOUND TO COMPLY WITH THE REQUIREMENTS OF

**UNI EN ISO 9001:2015**

QUESTO CERTIFICATO È VALIDO PER IL SEGUENTE CAMPO DI APPLICAZIONE  
THIS CERTIFICATE IS VALID FOR THE FOLLOWING SCOPE OF APPLICATION

**Progettazione, produzione e commercializzazione di raccorderia,  
rubinetteria e valvolame (IAF 18, 29)**

**Design, manufacture and trading of fittings, taps and valves  
(IAF 18, 29)**



SGQ N° 049A

Member of the Accredited Management System  
EA, AF e ILAC  
Signatory of CA, IR and ILAC Mutual  
Recognition Agreements

Per l'Organismo di Certificazione  
For the Certification Body  
**TÜV Italia S.r.l.**

Validità / Validity

Dal / From: 2025-05-06

Ai / To: 2028-05-05

**Francesco Scarlata**  
Direttore Divisione Business Assurance  
Business Assurance Division Manager

Data emissione /  
Issuing Date

2025-04-22

PRIMA CERTIFICAZIONE / FIRST CERTIFICATION: 2022-05-06

"LA VALIDITÀ DEL PRESENTE CERTIFICATO È SUBORDINATA A SORVEGLIANZA PERIODICA A 12 MESI E AL RIESAME COMPLETO DEL SISTEMA DI GESTIONE AZIENDALE CON PERIODICITÀ TRIENNALE"  
"THE VALIDITY OF THE PRESENT CERTIFICATE DEPENDS ON THE ANNUAL SURVEILLANCE EVERY 12 MONTHS AND ON THE COMPLETE REVIEW OF COMPANY'S MANAGEMENT SYSTEM AFTER THREE-YEARS"

Raccorderia per l'idraulica  
Brass fittings

## RACCORDERIA IN OTTONE SCHEDA INFORMATIVA

### MATERIALI UTILIZZATI PER LA REALIZZAZIONE DEL PRODOTTO

<b>Materia prima utilizzata</b> (a seconda delle misure degli articoli)	<b>LEGA 39Pb3</b> Barra in ottone trafilata in verghe - Lega Europea <b>CW 614 N</b> norma <b>UNI EN 12164</b>
	<b>LEGA EURO</b> Barra in ottone estrusa in verghe - Lega Europea <b>CW 617 N</b> norma <b>UNI EN 12165</b>
<b>O.Ring</b>	<ul style="list-style-type: none"> <li>• Mescola <b>01/H70 NBR</b> è idonea e certificata per impiego con gas, ad una temperatura di utilizzo, in continuo, da -20°C a +100°C. Non è compatibile con il vapore acqueo.</li> <li>• Mescola <b>01/B70 NBR</b> è idonea e certificata per impiego sia con gas che con acqua potabile, ad una temperatura di utilizzo, in continuo, da -20°C a +100°C. Non è compatibile con vapore acqueo.</li> <li>• Mescola <b>01/M70 HNBR</b> è idonea e certificata per impiego con gas, ad una temperatura di utilizzo, in continuo, da -40°C a +150°C.</li> </ul>
<b>Guarnizioni</b>	Fibra <b>FASIT</b> <i>esente da Amianto</i> per uso acqua, temperatura <b>max 180°C</b>

### PROCESSO DI LAVORAZIONE

<b>Da Barra Trafilata</b>	<ul style="list-style-type: none"> <li>• Filettatura su torni automatizzati</li> </ul>
<b>Da Barra Estrusa</b>	<ul style="list-style-type: none"> <li>• Stampaggio a caldo con riscaldamento della billette di barra, ad una temperatura di circa 720°C</li> <li>• Rimozione della sbavatura</li> <li>• Sabbatura del pezzo</li> <li>• Filettatura, (utilizzando macchine transfer o torni automatizzati).</li> </ul>
<b>Pulitura e Cromatura</b>	<ul style="list-style-type: none"> <li>• Smerigliatura</li> <li>• Burattatura</li> <li>• Cromatura (utilizzando NICKEL o CROMO) Lo spessore di circa 10 micron varia a seconda dell'articolo.</li> </ul>

### PROVE DURANTE LA LAVORAZIONE

- Misurazione con le relative attrezzature, delle altezze, diametri e spessori dei vari articoli
- Misurazione a tampone delle vari filettature
- Prove di pressione dei raccordi: min 10Bar max 25 Bar.

*I raccordi hanno il compito di unire due o più tubi tra di loro, o di chiudere tubi anche di diametri differenti. In corrispondenza dei raccordi, si hanno delle perdite di carico, che devono essere considerate durante la progettazione.*

### NORMATIVE DI RIFERIMENTO

UNI EN ISO 228 – FILETTATURE GAS  
 UNI EN ISO 2768 – TOLLERANZE  
 UNI EN ISO 9001:2015 – Sistema di gestione per la Qualità  
 UNI EN ISO 12165 + UNI EN ISO 10204 – MATERIA PRIMA UTILIZZATA



Raccorderia per l'idraulica  
Brass fittings

## Dichiarazione conformità dei prodotti

In qualità di produttore e di distributore di raccordi filettati in ottone giallo e cromato, idonei alla realizzazione di impianti idrotermosanitari, specifica che le filettature sono conformi alle norme europee.

La materia prima utilizzata è conforme alla norma UNI EN 12165 e nello specifico CW617 N-M con contenuto di piombo massimo ammesso del 2,2% e alla norma EN 10204 per CW614-N

PRESO ATTO

del D.M. n° 37/2008 "**Norme per la sicurezza degli impianti**"

DICHIARA

che i prodotti sono costruiti a regola d'arte e prodotti in ITALIA nel pieno rispetto delle norme igieniche, sanitarie e ambientali.

FP PATTARONI s.r.l.

La scelta della raccorderia e la corretta installazione sono responsabilità dell'installatore.



# FP PATTARONI

MADE IN ITALY

Raccorderia per l'idraulica  
Brass fittings

## BRASS FITTINGS TECHNICAL INFORMATION

### MATERIALS USED TO PRODUCE ITEMS

<b>Raw material</b> (It depends on Items' sizes)	<b>39Pb3 LEAGUE</b> Drawn brass bar - European League <b>CW 614 N</b> according to law <b>UNI EN 12164</b>
	<b>EURO LEAGUE</b> Extruded brass bar - European League <b>CW 617 N</b> according to law <b>UNI EN 12165</b>
<b>O.Ring</b>	<ul style="list-style-type: none"> <li>Mix <b>01/U70 NBR</b> is suitable and certified for gas using, temperature from -20°C to +100°C. Not suitable for water vapour.</li> <li>Mix <b>01/B70 NBR</b> is suitable and certified for gas using and potable water, temperature from -20°C to +100°C. Not suitable for water vapour.</li> <li>Mix <b>01/M70 HNBR</b> is suitable and certified for gas using, temperature from -40°C to +150°C.</li> </ul>
<b>Gaskets</b>	<b>FASIT</b> fibre <i>Asbestos-Free</i> for water use, <b>max</b> temperature <b>180°C</b>

### MANUFACTURING PROCESS

<b>Drawn Brass Bar</b>	<ul style="list-style-type: none"> <li>Threads will be turned on automatic lathes</li> </ul>
<b>Extruded Brass Bar</b>	<ul style="list-style-type: none"> <li>Pressing and stamping brass bar, heating the brass rod to temperature 720°C</li> <li>Remove the burring</li> <li>Sandblasting the Item</li> <li>Threading the item, (using transfer machine or automatic lathes).</li> </ul>
<b>Cleaning and chrome plating</b>	<ul style="list-style-type: none"> <li>Polishing</li> <li>Tumbling</li> <li>Chrome plating (using NICKEL or Chrome) The thickness is about 10 micron, and it depends on kind of Item.</li> </ul>

### PROCESSINGS' TESTS

- Measuring of height, diameters and thickness, using specific mechanical equipment
- Measuring of threads
- Pressure Tests of Fittings: min 10Bar max 25 Bar.

*Fittings are used to connect two or more pipes each others, or to close pipes with different diameters.  
In correspondence to fittings, there is load-less, that it will be considered during the project-phase.*

### REFERRING TO

UNI EN ISO 228 – GAS THREADED  
UNI EN ISO 2768 – GENERAL TOLERANCES  
UNI EN ISO 9001:2015 – QUALITY MANAGEMENT SYSTEM  
UNI EN ISO 12165 + UNI EN ISO 10204 – RAW MATERIAL

**FP PATTARONI s.r.l.** - Via dei Castagni, 3 - 28017 San Maurizio d'Opaglio (No) - Italia  
Tel. +39.0322.95.05.05 - Fax +39.0322.96.496 - [www.fpattaroni.it](http://www.fpattaroni.it) - [info@fpattaroni.it](mailto:info@fpattaroni.it) - P.IVA e C.F. 02467900037



Raccorderia per l'idraulica  
Brass fittings

## Declaration of conformity of products

As manufacturer and distributor of yellow and chrome-plated Brass Fittings, it declares that all our Items are suitable for any plumbing installation, and it specifies that the threads are in accordance with European standards.

The raw material complies the EN 12165 and in particular CW617 NM, and it is conformed to the European standards.

Products are perfectly done and they are produced in ITALY, fully complying with the hygiene, health and environmental norms.

FP PATTARONI s.r.l.

The choice of fittings and its correct use, are responsibility of hydrothermal systems installer.

**FP PATTARONI**

MADE IN ITALY

Raccorderia per l'idraulica  
Brass fittings

**DICHIARAZIONE CONFORMITA'  
AI SENSI DEL DECRETO MINISTERIALE  
DM174 DEL 06.04.2004**

*(Regolamento concernente i materiali e gli oggetti  
che possono essere utilizzati negli impianti fissi di captazione, trattamento,  
adduzione e distribuzione delle acque destinate al consumo umano)*

Vi invitiamo a contattarci per il rilascio dell'autocertificazione sopra indicata



**FP PATTARONI**

MADE IN ITALY

Raccorderia per l'idraulica  
Brass fittings

**DECLARATION OF CONFORMITY  
TO DM174 OF 06.04.2004**

*(Regulation concerning materials and objects that can be used  
in fixed systems for the collection, treatment, adduction and distribution  
of water intended for human consumption)*

You can contact our office to obtain our autocertification

## CONDIZIONI GENERALI DI VENDITA

Il CATALOGO-LISTINO 2025 è valido dal 01.06.2025 e sostituisce tutti i precedenti. Le vendite e le spedizioni vengono effettuate esclusivamente alle condizioni qui di seguito riportate. Esse si intendono accettate dal committente mediante il conferimento dell'ordine.

### ORDINAZIONI

Tutti gli ordini e relative modalità si intendono accettate solo dopo nostra approvazione scritta.

### PREZZI

I prezzi indicati si intendono esclusi IVA. Salvo accordi particolari, da precisare al conferimento dell'ordine, i prezzi si intendono sempre per merce resa franco nostra sede.

### PAGAMENTO

I pagamenti debbono essere effettuati alla ns. sede. In caso di ritardo pagamento rispetto alle scadenze pattuite, sarà addebitato l'interesse commerciale. Il ritardo pagamento di precedenti forniture ci autorizza ad annullare ogni ordine in corso. Le fatture si intendono integralmente accettate qualora esse non siano state contestate a mezzo PEC entro 8 (otto) giorni dalla loro emissione.

### CONSEGNE

I termini di consegna convenuti si intendono sempre puramente indicativi. Eventuali ritardi, da qualsiasi motivo causati, non daranno diritto al Committente a nessun indennizzo o compenso. L'annullamento di un ordine richiesto dal Committente (che dovrà essere fatto per iscritto) sarà eventualmente concesso a nostra discrezione e comunque mai dopo la consegna. La FP PATTARONI SRL si libera dell'obbligo della consegna rimettendo la cosa al Vettore o allo Spedizionario.

### SPEDIZIONE

La merce viaggia a rischio e per conto dell'Acquirente anche nel caso eccezionale di vendita "Franco Destino" ed anche se si tratta di merce resa.

Ogni eventuale reclamo in ordine alla spedizione dovrà essere comunicato ad FP PATTARONI SRL a mezzo PEC entro 8 (otto) giorni dal ricevimento della merce.

### GARANZIA

Tutti i nostri prodotti vengono provati e collaudati prima della spedizione. La nostra responsabilità è in ogni caso limitata alla sostituzione o riparazione dei pezzi difettosi resi franco ns sede. Nessun indennizzo sarà comunque da noi dovuto per danni diretti o indiretti causati dal prodotto risultato difettoso.

La FP PATTARONI SRL garantisce all'Acquirente il buon funzionamento del Bene per un periodo di 2 (due) anni dalla data di consegna.

La FP PATTARONI SRL si impegna a sostituire o riparare il Bene o i suoi singoli componenti, qualora, durante il suo utilizzo e nei limiti temporali sopra riportati, vengano riscontrati guasti o mal funzionamenti o vizi dello stesso derivanti da difetti di fabbricazione che lo rendano non più conforme all'uso per cui era stato destinato.

Le spese di riparazione o sostituzione del Bene sono a carico di FP PATTARONI SRL ma dovranno essere rese franco ns fabbrica.

L'Acquirente ai fini della presente garanzia, s'impegna, a pena di decadenza, a denunciare al Venditore ogni vizio di funzionamento del Bene entro e non oltre 8 (otto) giorni dalla sua conoscenza.

In caso di divergenza sulla qualità o condizioni della cosa venduta l'Acquirente dovrà chiedere la verifica nei modi stabiliti dagli articoli 696 e 696bis cpc e così a pena di decadenza entro 30 giorni dalla denuncia di cui al comma precedente.

La presente garanzia non copre i difetti o i danni causati dall'Acquirente a seguito di negligenza nell'uso o da non uso conforme del Bene rispetto a quello per il quale era destinato o causati da riparazioni, sostituzione di singoli componenti, manutenzioni effettuate da soggetti non autorizzati dal Venditore o da qualsivoglia circostanza indipendente dal fatto doloso o colposo del Venditore. In ogni caso il Venditore non garantisce il danno indiretto e non prevedibile.

### FORO COMPETENTE

Per ogni controversia si fissa come esclusivamente competente il Foro di Novara, e verrà disciplinata dalla legge italiana.

Le immagini di questo catalogo hanno valore puramente esemplificativo. FP Pattaroni si riserva di apportare modifiche tecniche ed estetiche agli articoli illustrati senza obbligo di preavviso. Salvo errori o errori tipografici.

## GENERAL CONDITIONS OF SALE

The CATALOGUE-LIST 2025 is valid from 01.06.2025 and replaces all previous ones. Sales and shipments are made only under the conditions set out below. They shall be deemed to have been accepted by the purchaser by means of the order.

### ORDERS

All orders requests are accepted only after our written approval.

### PRICES

VAT is not included in the prices. Except for special agreements, to be specified at the time of placing the order, prices are always for EXWORKS our headquarter.

### PAYMENT

Payments must be made to our headquarters. In the event of late payment in relation to the agreed deadlines, commercial interest will be charged. Late payment of previous deliveries entitles us to cancel any order in progress. Invoices shall be deemed to be fully accepted if they have not been contested by PEC within 8 (eight) days of their issuance.

### DELIVERIES

The agreed delivery terms are always purely indicative. Any delays caused by any reason shall not entitle the Customer to any compensation or compensation.

The cancellation of an order requested by the Customer (which must be made in writing) may be granted at our discretion and never after delivery. The FP PATTARONI SRL gets rid of the obligation of the delivery putting the thing to the Carrier or the Shipper.

### SHIPMENT

The goods travel at risk and on behalf of the Buyer even in the exceptional case of sale "Franco Destino" and even if it is returned goods.

Any claim in order to the shipment must be communicated to FP PATTARONI SRL by PEC within 8 (eight) days of receipt of the goods.

### GUARANTEE

All our products are tested and tested before shipping. Our responsibility is in any case limited to the replacement or repair of defective parts returned free of charge. No compensation shall be due by us for direct or indirect damage caused by the defective product.

FP PATTARONI SRL guarantees to the Purchaser the good functioning of the Good for a period of 2 (two) years from the date of delivery.

FP PATTARONI SRL undertakes to replace or repair the Good or its individual components, if, during its use and within the above time limits, faults or malfunctions or defects arising from manufacturing defects which render it no longer in conformity with the intended use are found.

The costs of repair or replacement of the Good are borne by FP PATTARONI SRL but must be made ex factory.

The Purchaser for the purposes of this guarantee, undertakes, under penalty of forfeiture, to report to the Seller any defect in the functioning of the Good no later than 8 (eight) days after its knowledge.

In case of divergence on the quality or conditions of the sold thing, the Buyer must ask for the verification in the manner established by articles 696 and 696bis cpc and so under penalty of forfeiture within 30 days from the denunciation referred to in the previous paragraph.

This warranty does not cover defects or damage caused by the Purchaser as a result of negligence in the use or use of the Good in accordance with the one for which it was intended or caused by repairs, replacement of individual components, maintenance carried out by persons not authorised by the Seller or by any circumstance independent of the intentional or negligent act of the Seller.

In any case, the Seller does not guarantee indirect and unpredictable damage.

### COMPETENT COURT

For each dispute the Court of Novara is exclusively competent, and will be governed by Italian law.

Images on this catalogue have only the set purpose of present the product. FP Pattaroni reserves the right to make technical and aesthetic alterations on illustrated items without previous notice. Any errors or typos exepcted.



Ⓟ  
FP PATTARONI  
MADE IN ITALY



Sul nostro sito troverai la nuovissima sezione dedicata all'e-commerce, dove potrai consultare e ordinare direttamente ciò che ti serve.

On our site you will find the brand new e-commerce section, where you can browse and order directly what you need.

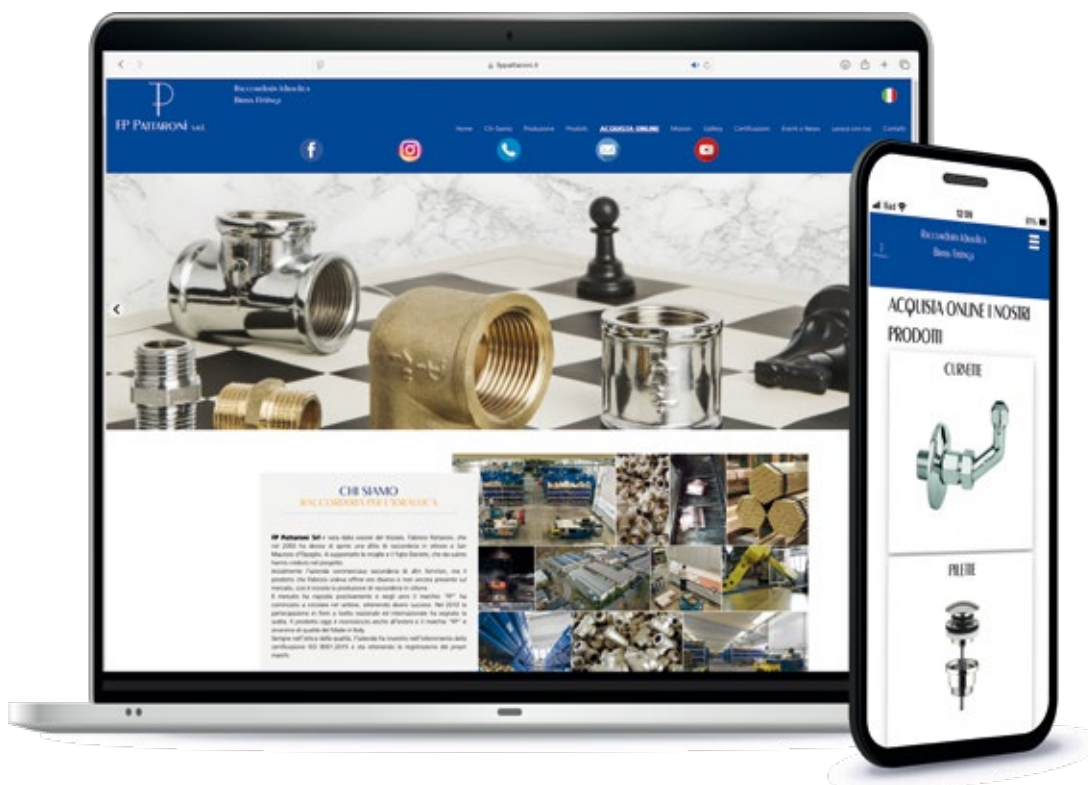

## PATTARONI RUBINETTERIE

Nell'ottica di incrementare la propria presenza sul mercato, è stato creato un nuovo marchio: una linea di miscelatori di design che si ispira ai valori aziendali, quali mission e vision.

In order to increase its market presence, a new brand was created: a line of designer mixers inspired by the company's values, mission and vision.



**RICHIEDI IL CATALOGO!**

**REQUEST THE CATALOGUE!**

[www.pattaroni.com](http://www.pattaroni.com)



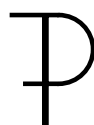

# FP PATTARONI

MADE IN ITALY

**FP Pattaroni S.r.l.**

SEDE LEGALE: Via dei Castagni, 3  
28017 San Maurizio d'Opaglio - NO - Italy

SEDE OPERATIVA: Via dell'Erica, 10  
28017 San Maurizio d'Opaglio - NO - Italy

Ph. +39 0322 95 05 05  
info@fppattaroni.it

[www.fppattaroni.it](http://www.fppattaroni.it)



Taggaci nelle foto dei nostri prodotti  
*Tag us in the photos of our products*  
**#pattaroni**

Seguici sulla nostra pagina ufficiale  
*Follow us on our official page*  
**@fp.pattaroni\_srl**



